

Robert Bosch Power Tools GmbH
70538 Stuttgart
GERMANY

www.bosch-pt.com

1 609 92A 41B (2017.10) T / 42



1 609 92A 41B

GST 25 M Professional

 **BOSCH**

en Original instructions
cn 正本使用说明书
tw 原始使用說明書
ko 사용 설명서 원본
th หนังสือคู่มือการใช้งานฉบับต้นแบบ
id Petunjuk-Petunjuk untuk Penggunaan Orisinal
vi Bản gốc hướng dẫn sử dụng



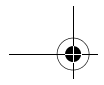

English	Page	3
中文	页	9
中文	頁	12
한국어	페이지	16
ภาษาไทย	หน้า	19
Bahasa Indonesia	Halaman	24
Tiếng Việt	Trang	28

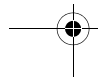
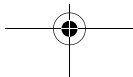
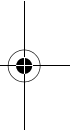
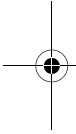

English

General Power Tool Safety Warnings

⚠ WARNING Read all safety warnings and all instructions. Failure to follow the warnings and instructions may result in electric shock, fire and/or serious injury.

Save all warnings and instructions for future reference.

The term "power tool" in the warnings refers to your mains-operated (corded) power tool or battery-operated (cordless) power tool.

Work area safety

- ▶ **Keep work area clean and well lit.** Cluttered or dark areas invite accidents.
- ▶ **Do not operate power tools in explosive atmospheres, such as in the presence of flammable liquids, gases or dust.** Power tools create sparks which may ignite the dust or fumes.
- ▶ **Keep children and bystanders away while operating a power tool.** Distractions can cause you to lose control.

Electrical safety

- ▶ **Power tool plugs must match the outlet. Never modify the plug in any way. Do not use any adapter plugs with earthed (grounded) power tools.** Unmodified plugs and matching outlets will reduce risk of electric shock.
- ▶ **Avoid body contact with earthed or grounded surfaces, such as pipes, radiators, ranges and refrigerators.** There is an increased risk of electric shock if your body is earthed or grounded.
- ▶ **Do not expose power tools to rain or wet conditions.** Water entering a power tool will increase the risk of electric shock.
- ▶ **Do not abuse the cord. Never use the cord for carrying, pulling or unplugging the power tool. Keep cord away from heat, oil, sharp edges and moving parts.** Damaged or entangled cords increase the risk of electric shock.
- ▶ **When operating a power tool outdoors, use an extension cord suitable for outdoor use.** Use of a cord suitable for outdoor use reduces the risk of electric shock.
- ▶ **If operating a power tool in a damp location is unavoidable, use a residual current device (RCD) protected supply.** Use of an RCD reduces the risk of electric shock.

Personal safety

- ▶ **Stay alert, watch what you are doing and use common sense when operating a power tool. Do not use a power tool while you are tired or under the influence of drugs, alcohol or medication.** A moment of inattention while operating power tools may result in serious personal injury.
- ▶ **Use personal protective equipment. Always wear eye protection.** Protective equipment such as dust mask, non-skid safety shoes, hard hat, or hearing protection used for appropriate conditions will reduce personal injuries.

- ▶ **Prevent unintentional starting. Ensure the switch is in the off-position before connecting to power source and/or battery pack, picking up or carrying the tool.** Carrying power tools with your finger on the switch or energising power tools that have the switch on invites accidents.
- ▶ **Remove any adjusting key or wrench before turning the power tool on.** A wrench or a key left attached to a rotating part of the power tool may result in personal injury.
- ▶ **Do not overreach. Keep proper footing and balance at all times.** This enables better control of the power tool in unexpected situations.
- ▶ **Dress properly. Do not wear loose clothing or jewellery. Keep your hair, clothing and gloves away from moving parts.** Loose clothes, jewellery or long hair can be caught in moving parts.
- ▶ **If devices are provided for the connection of dust extraction and collection facilities, ensure these are connected and properly used.** Use of dust collection can reduce dust-related hazards.

Power tool use and care

- ▶ **Do not force the power tool. Use the correct power tool for your application.** The correct power tool will do the job better and safer at the rate for which it was designed.
- ▶ **Do not use the power tool if the switch does not turn it on and off.** Any power tool that cannot be controlled with the switch is dangerous and must be repaired.
- ▶ **Disconnect the plug from the power source and/or the battery pack from the power tool before making any adjustments, changing accessories, or storing power tools.** Such preventive safety measures reduce the risk of starting the power tool accidentally.
- ▶ **Store idle power tools out of the reach of children and do not allow persons unfamiliar with the power tool or these instructions to operate the power tool.** Power tools are dangerous in the hands of untrained users.
- ▶ **Maintain power tools. Check for misalignment or binding of moving parts, breakage of parts and any other condition that may affect the power tool's operation. If damaged, have the power tool repaired before use.** Many accidents are caused by poorly maintained power tools.
- ▶ **Keep cutting tools sharp and clean.** Properly maintained cutting tools with sharp cutting edges are less likely to bind and are easier to control.
- ▶ **Use the power tool, accessories and tool bits etc. in accordance with these instructions, taking into account the working conditions and the work to be performed.** Use of the power tool for operations different from those intended could result in a hazardous situation.

Service

- ▶ **Have your power tool serviced by a qualified repair person using only identical replacement parts.** This will ensure that the safety of the power tool is maintained.

4 | English

Safety Warnings for Jigsaws











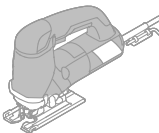



- ▶ **Hold power tool by insulated gripping surfaces, when performing an operation where the cutting accessory may contact hidden wiring or its own cord.** Cutting accessory contacting a "live" wire may make exposed metal parts of the power tool "live" and could give the operator an electric shock.









Additional Safety and Working Instructions

- ▶ **Keep hands away from the sawing range. Do not reach under the workpiece.** Contact with the saw blade can lead to injuries.
- ▶ **Apply the machine to the workpiece only when switched on.** Otherwise there is danger of kickback when the cutting tool jams in the workpiece.
- ▶ **Pay attention that the base plate rests securely on the material while sawing.** A jammed saw blade can break or lead to kickback.
- ▶ **When the cut is completed, switch off the machine and then pull the saw blade out of the cut only after it has come to a standstill.** In this manner you can avoid kickback and can place down the machine securely.
- ▶ **Use only undamaged saw blades that are in perfect condition.** Bent or dull saw blades can break, negatively influence the cut, or lead to kickback.
- ▶ **Do not brake the saw blade to a stop by applying side pressure after switching off.** The saw blade can be damaged, break or cause kickback.
- ▶ **Use suitable detectors to determine if utility lines are hidden in the work area or call the local utility company for assistance.** Contact with electric lines can lead to fire and electric shock. Damaging a gas line can lead to explosion. Penetrating a water line causes property damage or may cause an electric shock.
- ▶ **Secure the workpiece.** A workpiece clamped with clamping devices or in a vice is held more secure than by hand.
- ▶ **Always wait until the machine has come to a complete stop before placing it down.** The tool insert can jam and lead to loss of control over the power tool.
- ▶ **Before any work on the machine itself, pull the mains plug.**
- ▶ **The saw blade should not be longer than required for the intended cut. Use a narrow saw blade when sawing tight curves.**
- ▶ **Check the tight seating of the saw blade.** A loose saw blade can fall out and lead to injuries.
- ▶ **When ejecting the saw blade, hold the machine in such a manner that no persons or animals can be injured by the ejected saw blade.**
- ▶ **Dust from materials such as lead-containing coatings, some wood types, minerals and metal can be harmful to one's health and cause allergic reactions, lead to respiratory infections and/or cancer.** Materials containing asbestos may only be worked by specialists.
 - Provide for good ventilation of the working place.
 - It is recommended to wear a P2 filter-class respirator.
 Observe the relevant regulations in your country for the materials to be worked.
- ▶ **Prevent dust accumulation at the workplace.** Dust can easily ignite.
- ▶ **Observe correct mains voltage! The voltage of the power source must agree with the voltage specified on the nameplate of the machine. Power tools marked with 230 V can also be operated with 220 V.**
- ▶ **The contact protector attached to the casing (see figure 12, page 39) prevents accidental touching of the saw blade during the working procedure and may not be removed.**
- ▶ **Before sawing in wood, particle boards, building materials etc., check for foreign objects, such as nails, screws, etc. and remove them as required.**
- ▶ **Plunge cuts may only be applied to soft materials, such as wood, gypsum board, etc.**
- ▶ **The splinter guard can prevent fraying of the surface while sawing wood.**
- ▶ **Adapt the settings of your power tool to the respective application. For example, reduce the stroke rate and orbital action when cutting metal or for tight curved cuts.**
- ▶ **In extreme conditions, always use dust extraction as far as possible. Blow out ventilation slots frequently and install a portable residual current device (PRCD).** When working metals, conductive dust can settle in the interior of the power tool. The total insulation of the power tool can be impaired.
- ▶ **Products sold in GB only:** Your product is fitted with a BS 1363/A approved electric plug with internal fuse (ASTA approved to BS 1362). If the plug is not suitable for your socket outlets, it should be cut off and an appropriate plug fitted in its place by an authorised customer service agent. The replacement plug should have the same fuse rating as the original plug. The severed plug must be disposed of to avoid a possible shock hazard and should never be inserted into a mains socket elsewhere.
- ▶ **Products sold in AUS and NZ only:** Use a residual current device (RCD) with a rated residual current of 30 mA or less.

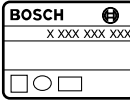
Symbols

The following symbols are important for reading and understanding the operating instructions. Please take note of the symbols and their meaning. The correct interpretation of the symbols will help you to use the machine in a better and safer manner.

Symbol	Meaning
	GST 25 M: Jigsaw with constant electronic and bow handle Grey-marked area: Handle (insulated gripping surface)
	Read all safety warnings and all instructions
	Before any work on the machine itself, pull the mains plug from the socket outlet
	Wear protective gloves
	Additional information
	Movement direction
	Reaction direction
	Next step of action
	Sawdust blower device
	Low stroke rate
	High stroke rate
	Switching On
	Switching Off
	On/Off switch lock-on

Symbol	Meaning
	Prohibited action
	Correct result
	When sawing metal, apply coolant/lubricant alongside the cutting line
	Article number (10-digit)
P_1	Rated power input
n_0	No-load stroke rate
	Cutting depth, max.
	Wood
	Aluminium
	Metal
	Weight according to EPTA-Procedure 01:2014
	Symbol for protection class II (completely insulated)

Delivery Scope

Jigsaw.
Splinter guard, parallel guide, application tools and other accessories shown or described are not part of the standard delivery scope.

A complete overview of accessories can be found in our accessories program.

Intended Use

The machine is intended for making separating cuts and cut-outs in wood, plastic, metal, ceramic plates and rubber while resting firmly on the workpiece. It is suitable for straight and curved cuts. The saw blade recommendations are to be observed.

Technical Data

The technical data of the machine are listed in the table on page 33.

The values given are valid for a nominal voltage [U] of 230 V. For different voltages and models for specific countries, these values can vary.

Mounting and Operation

Action	Figure	Page
Inserting the Saw Blade	1	34
Ejecting the Saw Blade	2	34
Switching on the sawdust blower device	3	35
Mounting the splinter guard	4	35
Orbital Action Settings	5	35
Adjusting the stroke rate preselection	6	36
Switching On and Off	7	36
Lubrication when cutting metal	8	37
Plunge Cutting	9	37
Mounting the Dust Cover	10	37
Mounting and use of the parallel guide	11	38
Selecting Accessories	-	40 – 41

Maintenance and Cleaning

► **For safe and proper working, always keep the machine and the ventilation slots as well as the tool holder clean.**

If the replacement of the supply cord is necessary, this has to be done by Bosch or an authorized Bosch service agent in order to avoid a safety hazard.

Clean the saw blade holder regularly. For this, remove the saw blade from the machine and lightly tap out the machine on a level surface.

Check the guide roller regularly. If worn, it must be replaced through an authorised Bosch after-sales service agent.

Lubricate the guide roller occasionally with a drop of oil (see figure 13, page 39).

After-sales Service and Application Service

Our after-sales service responds to your questions concerning maintenance and repair of your product as well as spare parts. Exploded views and information on spare parts can also be found under:

www.bosch-pt.com

Bosch's application service team will gladly answer questions concerning our products and their accessories.

In all correspondence and spare parts orders, please always include the 10-digit article number given on the nameplate of the product.

Cambodia

Robert Bosch (Cambodia) Co., Ltd
Unit 8BC, GT Tower, 08th Floor, Street 169,
Czechoslovakia Blvd, Sangkat Veal Vong
Khan 7 Makara, Phnom Penh
VAT TIN: 100 169 511
Tel.: +855 23 900 685
Tel.: +855 23 900 660
www.bosch.com.kh

People's Republic of China

China Mainland
Bosch Power Tools (China) Co., Ltd.
567, Bin Kang Road
Bin Jiang District 310052
Hangzhou, P. R. China
Tel.: 4008268484
Fax: (0571) 87774502
E-Mail: contact.ptcn@cn.bosch.com
www.bosch-pt.com.cn

HK and Macau Special Administrative Regions

Robert Bosch Co. Ltd.
21st Floor, 625 King's Road
North Point, Hong Kong
Customer Service Hotline: +852 2101 0235
Fax: +852 2590 9762
E-Mail: info@hk.bosch.com
www.bosch-pt.com.hk

India

Bosch Service Center
69, Habibullah Road, (Next to PSBB School), T. Nagar
Chennai – 600077
Phone: (044) 64561816

Bosch Service Center Rishyamook
85A, Panchkuin Road
New Delhi – 110001
Phone: (011) 43166190

Bosch Service Center
79, Crystal Bldg., Dr. Annie Besant Road, Worli
Mumbai – 400018
Phone: (022) 39569936 / (022) 39569959 /
(022) 39569967 / (022) 24952071

Indonesia

PT Robert Bosch
Palma Tower 10th Floor
Jalan RA Kartini II-S Kaveling 6
Pondok Pinang, Kebayoran Lama
Jakarta Selatan 12310
Tel.: (21) 3005-5800
www.bosch-pt.co.id

Malaysia

Robert Bosch Sdn. Bhd. (220975-V) PT/SMY
 No. 8A, Jalan 13/6
 46200 Petaling Jaya
 Selangor
 Tel.: (03) 79663194
 Toll-Free: 1800 880188
 Fax: (03) 79583838
 E-Mail: kiathoe.chong@my.bosch.com
 www.bosch-pt.com.my

Pakistan

Robert Bosch Middle East FZE – Pakistan Liaison Office
 2nd Floor Plaza # 10, CCA Block, DHA Phase 5
 Lahore, 54810
 Phone: +92(303)4444311
 Email: Faisal.Khan@bosch.com

Philippines

Robert Bosch, Inc.
 28th Floor Fort Legend Towers,
 3rd Avenue corner 31st Street,
 Fort Bonifacio, Global City,
 1634 Taguig City
 Tel.: (632) 8703871
 Fax: (632) 8703870
 www.bosch-pt.com.ph

Singapore

Powerwell Service Centre Ptd Ltd
 Bosch Authorised Service Centre (Power Tools)
 4012 Ang Mo Kio Ave 10, #01-02 TECHplace
 Singapore 569628
 Tel.: 6452 1770
 Fax: 6452 1760
 E-Mail: ask@powerwellsc.com
 www.powerwellsc.com
 www.bosch-pt.com.sg

Thailand

Robert Bosch Ltd.
 Liberty Square Building
 No. 287, 11 Floor
 Silom Road, Bangrak
 Bangkok 10500
 Tel.: 02 6393111
 Fax: 02 2384783
 Robert Bosch Ltd., P. O. Box 2054
 Bangkok 10501
 www.bosch.co.th
 Bosch Service – Training Centre
 La Salle Tower Ground Floor Unit No.2
 10/11 La Salle Moo 16
 Srinakharin Road
 Bangkaew, Bang Plee
 Samutprakarn 10540
 Tel.: 02 7587555
 Fax: 02 7587525

Vietnam

Branch of Bosch Vietnam Co., Ltd in HCMC
 Floor 10, 194 Golden Building
 473 Dien Bien Phu Street
 Ward 25, Binh Thanh District, Ho Chi Minh City
 Tel.: (08) 6258 3690
 Fax: (08) 6258 3692
 Hotline: (08) 6250 8555
 www.bosch-pt.com.vn

Armenia, Azerbaijan, Georgia, Kyrgyzstan, Mongolia, Tajikistan, Turkmenistan, Uzbekistan

TOO "Robert Bosch" Power Tools, After Sales Service
 Rayimbek Ave., 169/1
 050050, Almaty, Kazakhstan
 Service Email: service.pt.ka@bosch.com
 Official Website: www.bosch.com, www.bosch-pt.com

Bahrain

Hatem Al Juffali Technical Equipment Establishment.
 Kingdom of Bahrain, Setra Highway, Al Aker Area
 Phone: +966126971777-311
 Fax: +97317704257
 Email: h.berjas@ejab.com.sa

Egypt

Unimar
 20 Markaz kadmat
 El tagmoa EL Aoul – New Cairo
 Phone: + 20 2224 76091-95
 Phone: + 20 2224 78072-73
 Fax: + 20 2224 78075
 Email: adelzaki@unimaregypt.com

Iran

Robert Bosch Iran
 3rd Floor, No 3, Maadiran Building
 Aftab St., Khodami St., Vanak Sq.
 Tehran 1994834571
 Phone: +9821- 86092057

Iraq

Sahba Technology Group
 Al Muthana airport road
 Baghdad
 Phone: +9647901906953
 Phone Dubai: +97143973851
 Email: bosch@sahbatechnology.com

Jordan

Roots Arabia – Jordan
 Nasser Bin Jameel street, Building 37 Al Rabiah
 11194 Amman
 Phone: +962 6 5545778
 Email: bosch@rootsjordan.com

8 | English

Kuwait

Al Qurain Automotive Trading Company
 Shuwaikh Industrial Area, Block 1, Plot 16, Street 3rd
 P.O. Box 164 – Safat 13002
 Phone: 24810844
 Fax: 24810879
 E-mail: josephkr@aaalmutawa.com

Lebanon

Tehini Hana & Co. S.A.R.L.
 P.O. Box 90-449
 Jdeideh
 Dora-Beirut
 Phone: +9611255211
 Email: service-pt@tehini-hana.com

Libya

El Naser for Workshop Tools
 Swanee Road, Alfalah Area
 Tripoli
 Phone: +218 21 4811184

Oman

Malatan Trading & Contracting LLC
 P.O. Box 131
 Ruwi, 112 Sultanate of Oman
 Phone: +968 99886794
 Email: malatanpowertools@malatan.net

Qatar

International Construction Solutions W L L
 P. O. Box 51, Doha
 Phone: +974 40065458
 Fax: +974 4453 8585
 Email: csd@icsdoha.com

Saudi Arabia

Juffali Technical Equipment Co. (JTECO)
 Kilo 14, Madinah Road, Al Bawadi District
 Jeddah 21431
 Phone: +966 2 6672222 Ext. 1528
 Fax: +966 2 6676308
 Email: roland@ejb.com.sa

Syria

Dallal Establishment for Power Tools
 P.O. Box 1030
 Aleppo
 Phone: +963212116083
 Email: rita.dallal@hotmail.com

United Arab Emirates

Central Motors & Equipment LLC, P.O. Box 1984
 Al-Wahda Street – Old Sana Building
 Sharjah
 Phone: +971 6 593 2777
 Fax: +971 6 533 2269
 Email: powertools@centralmotors.ae

Yemen

Abualrejal Trading Corporation
 Sana'a Zubairy St. Front to new Parliament Building
 Phone: +967-1-202010
 Fax: +967-1-279029
 Email: tech-tools@abualrejal.com

Ethiopia

Forever plc
 Kebele 2,754, BP 4806,
 Addis Ababa
 Phone: +251 111 560 600
 Email: foreverplc@ethionet.et

Ghana

C. WOERMANN LTD.
 Nsawam Road/Avenor Junction, P.O. Box 1779
 Accra
 Phone: +233 302 225 141

Kenya

Robert Bosch East Africa Ltd
 Mpaka Road P.O. Box 856
 00606 Nairobi

Nigeria

Robert Bosch Nigeria Ltd.
 52 – 54 Isaac John Street P.O. Box
 GRA Ikeja – Lagos

Republic of South Africa

Customer service
 Hotline: (011) 6519600

Gauteng – BSC Service Centre

35 Roper Street, New Centre
 Johannesburg
 Tel.: (011) 4939375
 Fax: (011) 4930126
 E-Mail: bsctools@icon.co.za

KZN – BSC Service Centre

Unit E, Almar Centre
 143 Crompton Street
 Pinetown
 Tel.: (031) 7012120
 Fax: (031) 7012446
 E-Mail: bsc.dur@za.bosch.com

Western Cape – BSC Service Centre

Democracy Way, Prosperity Park
 Milnerton
 Tel.: (021) 5512577
 Fax: (021) 5513223
 E-Mail: bsc@zsd.co.za

Bosch Headquarters

Midrand, Gauteng
 Tel.: (011) 6519600
 Fax: (011) 6519880
 E-Mail: rbsa-hq.pts@za.bosch.com

Tanzania

Diesel & Autoelectric Service Ltd.
117 Nyerere Rd., P.O. Box 70839
Vingunguti 12109, Dar Es Salaam
Phone: +255 222 861 793/794

Australia, New Zealand and Pacific Islands

Robert Bosch Australia Pty. Ltd.
Power Tools
Locked Bag 66
Clayton South VIC 3169
Customer Contact Center
Inside Australia:
Phone: (01300) 307044
Fax: (01300) 307045

Inside New Zealand:
Phone: (0800) 543353
Fax: (0800) 428570

Outside AU and NZ:
Phone: +61 3 95415555
www.bosch-pt.com.au
www.bosch-pt.co.nz

Disposal

The machine, accessories and packaging should be sorted for environmental-friendly recycling.



Do not dispose of power tools into household waste!

Subject to change without notice.

中文**电动工具通用安全警告**

警告！ 阅读所有警告和所有说明！不遵照以下警告和说明会导致电击、着火和/或严重伤害。

保存所有警告和说明书以备查阅。

在所有下列的警告中术语“电动工具”指市电驱动（有线）电动工具或电池驱动（无线）电动工具。

工作场地的安全

- ▶ **保持工作场地清洁和明亮。** 混乱和黑暗的场地会引发事故。
- ▶ **不要在易爆环境，如有易燃液体、气体或粉尘的环境下操作电动工具。** 电动工具产生的火花会点燃粉尘或气体。
- ▶ **让儿童和旁观者离开后操作电动工具。** 注意力不集中会使操作者失去对工具的控制。

电气安全

- ▶ **电动工具插头必须与插座相配。绝不能以任何方式改装插头。** 需接地的电动工具不能使用任何转换插头。未经改装的插头和相配的插座将减少电击危险。
- ▶ **避免人体接触接地表面，如管道、散热片和冰箱。** 如果你身体接地会增加电击危险。
- ▶ **不得将电动工具暴露在雨中或潮湿环境中。** 水进入电动工具将增加电击危险。
- ▶ **不得滥用电线。绝不能用电线搬运、拉动电动工具或拔出其插头。** 使电线远离热源、油、锐边或运动部件。受损或缠绕的软线会增加电击危险。
- ▶ **当在户外使用电动工具时，使用适合户外使用的外接软线。** 适合户外使用的软线将减少电击危险。
- ▶ **如果在潮湿环境下操作电动工具是不可避免的，应使用剩余电流动作保护器（RCD）。** 使用 RCD 可减小电击危险。

人身安全

- ▶ **保持警觉，当操作电动工具时关注所从事的操作并保持清醒。** 当你感到疲倦，或在有药物、酒精或治疗反应时，不要操作电动工具。在操作电动工具时瞬间的疏忽会导致严重人身伤害。
- ▶ **使用个人防护装置。始终佩戴护目镜。** 安全装置，诸如适当条件下使用防尘面具、防滑安全鞋、安全帽、听力防护等装置能减少人身伤害。
- ▶ **防止意外起动。确保开关在连接电源和/或电池盒、拿起或搬运工具时处于关断位置。** 手指放在已接通电源的开关上或开关处于接通时插入插头可能会导致危险。
- ▶ **在电动工具接通之前，拿掉所有调节钥匙或扳手。** 遗留在电动工具旋转零件上的扳手或钥匙会导致人身伤害。
- ▶ **手不要伸展得太长。时刻注意立足点和身体平衡。** 这样在意外情况下能很好地控制电动工具。
- ▶ **着装适当。不要穿宽松衣服或佩戴饰品。让衣服、手套和头发远离运动部件。** 宽松衣服、佩饰或长发可能会卷入运动部件中。
- ▶ **如果提供了与排屑、集尘设备连接用的装置，要确保他们连接完好且使用得当。** 使用这些装置可减少尘屑引起的危险。

电动工具使用和注意事项

- ▶ **不要滥用电动工具，根据用途使用适当的电动工具。** 选用适当设计的电动工具会使你工作更有效、更安全。
- ▶ **如果开关不能接通或关断工具电源，则不能使用该电动工具。** 不能用开关来控制的电动工具是危险的且必须进行修理。

10 | 中文

- ▶ 在进行任何调节、更换附件或贮存电动工具之前，必须从电源上拔掉插头和 / 或使电池盒与工具脱离。这种防护性措施将减少工具意外起动的危险。
- ▶ 将闲置不用的电动工具贮存在儿童所及范围之外，并且不要让不熟悉电动工具或对这些说明不了解的人操作电动工具。电动工具在未经培训的用户手中是危险的。
- ▶ 保养电动工具。检查运动件是否调整到位或卡住，检查零件破损情况和影响电动工具运行的其他状况。如有损坏，电动工具应在使用前修理好。许多事故由维护不良的电动工具引发。
- ▶ 保持切削刀具锋利和清洁。保养良好的有锋利切削刃的刀具不易卡住而且容易控制。
- ▶ 按照使用说明书，考虑作业条件和进行的作业来使用电动工具、附件和工具的刀头等。将电动工具用于那些与其用途不符的操作可能会导致危险。

维修

- ▶ 将你的电动工具送交专业维修人员，使用同样的备件进行修理。这样将确保所维修的电动工具的安全性。

针对线锯的安全规章

- ▶ 在切削附件可能触及暗线或其自身软线之处进行操作时，要通过绝缘握持面来握持工具。切削附件碰到带电导线会使工具外露的金属零件带电从而使操作者受到电击。



进一步的安全规章和工作指示







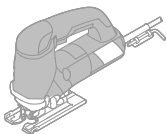











- ▶ 双手必须远离锯割范围，手不可以握在工件下端。如果不小心中碰触了锯片可能被割伤。
- ▶ 先开动电动工具后再把工具放置在工件上切割。如果电动工具被夹在工件中，会有反击的危险。
- ▶ 锯割时必须把底盘正确地放置在工件上。锯片如果歪斜了，可能断裂或者造成反击。
- ▶ 工作告一段落时，必须先关闭电动工具并等待机器完全静止后，才可以从锯缝中拔出锯刀。如此不但可以防止反击，而且可以防止放置机器时发生危险。
- ▶ 只能使用未受损，功能正常的锯片。弯曲或变钝的锯片可能断裂，对锯痕造成负面影响或导致反弹。
- ▶ 关机后不可以侧压刀片来制止仍然继续转动的刀片。锯刀可能因此受损、断裂或者造成反击。
- ▶ 使用合适的侦测装置侦察隐藏的电线，或者向当地的相关单位寻求支援。接触电线可能引起火灾并让操作者触电。损坏了瓦斯管会引起爆炸。凿穿水管不仅会造成严重的财物损失，也可能导致触电。
- ▶ 固定好工件。使用固定装置或老虎钳固定工件，会比用手持握工件更牢固。
- ▶ 等待电动工具完全静止后才能放下机器。机器上的工具可能在工作中被夹住，而令您无法控制电动工具。





- ▶ 维修电动工具或换装零、配件之前，务必从插座上拔出插头。
- ▶ 锯刀不可以比预定的锯线长。在狭小的弯角上锯割时要使用窄的锯刀。
- ▶ 检查锯刀是否已经装牢了。松动的锯刀可能掉落并伤害您。
- ▶ 抛出锯刀时千万要握好电动工具，不可以让弹出的锯刀伤害旁人或动物。
- ▶ 含铅的颜料以及某些木材、矿物和金属的加工粉尘有害健康、可能造成过敏、让操作者感染呼吸道疾病和 / 或罹患癌症。只有经过专业训练的人员才能够加工含石棉的物料。
 - 工作场所要保持空气流通。
 - 最好佩戴 P2 滤网等级的口罩。
 请留心并遵守贵国和加工物料有关的法规。
- ▶ 避免让工作场所堆积过多的尘垢。尘埃容易被点燃。
- ▶ 注意电源的电压！电源的电压必须和电动工具铭牌上标示的电压一致。
- ▶ 安装在机壳上的防护把手（参考图 12，页数 39）能够防止操作者意外地碰触锯刀，不可以拆除防护把手。
- ▶ 在木材、木屑夹板及建材上锯割时必须检查是否有暗藏的异物，例如钉子、螺钉等。必要时得清除异物。
- ▶ 进行潜锯时必须挑选软的物料，例如木材，石膏板等。
- ▶ 防毛边压板可以防止锯割木材时，撕毁工件表面。
- ▶ 根据用途适当地调整电动工具的设定。例如加工金属和在狭窄的弯角上锯割时，必须降低冲击和振荡摆动的次数。
- ▶ 在某些极端的操作环境下，如果可能的话一定要使用吸尘装备。吹除通气孔中的污垢并且要使用故障电流保护开关（PRCD）。加工金属时可能在电动工具的内部堆积会导电的废尘。这样可能会影响电动工具的安全绝缘性能。

代表符号

以下的符号可以帮助您正确地使用本机器。请详细阅读各符号及它们的代表意思。正确了解各符号所代表的意义，可以帮助您更有把握更安全地操作本机器。

符号	含义
	GST 25 M: 配备恒定电子装备和弓形握柄的线锯 打上灰色记号的部位：手柄（绝缘的握持位置）
	阅读所有的安全规章和说明

符号	含义
	在电动工具上进行任何修护工作之前必须从电源插座上拔出插头
	佩戴防护手套
	附加资讯
	移动方向
	反应方向
	下一个处理步骤
	针对锯屑的吹气装置
	小冲击次数
	高冲击次数
	开动
	关闭
	锁定起停开关
	禁止的行为
	正确的结果
	锯割金属时必须沿著锯割线涂抹冷却剂或润滑剂
	产品编号 (10 位数)
P_1	额定输入功率
n_0	无负载冲击次数
	最大锯割深度
	木材

符号	含义
	铝板
	金属
	重量符合 EPTA—Procedure 01:2014
	绝缘等级 II 的代表符号 (完全绝缘)

供货范围

线锯。

防毛边压板，平行挡块，锯片和其它被标示的或经过描述的附件并不包含在基本供货范围中。

在本公司的附件清单中标列了完整的附件。

按照规定使用机器

本机器可以在稳固的底垫上，进行切割、挖割。适用的材料包括木材、塑胶、金属、陶片和橡胶等。本机器不仅能够直锯，也可以锯弯角。请使用本公司推荐的锯刀片。

技术数据

本产品的技术数据列在本使用说明书 33 页的表格中。

本说明书提供的参数是以 230 V 为依据，於低电压地区，此数据有可能不同。

安装和操作

执行目的	图片	页数
安装锯刀	1	34
抛出锯刀	2	34
开动吹气装置	3	35
安装防毛边压板	4	35
调整振荡功能	5	35
调整冲击次数	6	36
开动 / 关闭	7	36
加工金属时的润滑工作	8	37
潜锯	9	37
安装遮盖罩	10	37
安装和使用平行挡块	11	38
选择附件	-	40 - 41

维修和清洁

► 电动工具，通气孔以及工具接头要随时保持清洁，以确保能够有把握且安全地操作电动工具。

如果必须更换连接线，务必把这项工作交给博世或者经授权的博世电动工具顾客服务执行，以避免危害机器的安全性能。

12 | 中文

定期清洁锯刀接头。此时必须先从电动工具中拆下锯刀，并且在平坦的表面上轻敲电动工具，以便抖落污垢。

定期检查导引轮 是否磨损了。如果确定导引轮已经损坏，必须把机器交给经过授权的博世客户服务中心更换导引轮。

适时地使用 一滴润滑油导引轮（参考图 13，页码 39）。

顾客服务处和顾客咨询中心

本公司顾客服务处负责回答有关本公司产品的修理、维护和备件的问题。以下的网页中有爆炸图和备件的资料：

www.bosch-pt.com

博世顾客咨询团队非常乐意为您解答有关本公司产品及附件的问题。

如需查询和订购备件，请务必提供产品型号铭牌上的 10 位数货号。

有关保证、维修或更换零件事宜，请向合格的经销商查询。

中国大陆

博世电动工具（中国）有限公司

中国 浙江省 杭州市

滨江区滨康路 567 号

邮政编码：310052

免费服务热线：4008268484

传真：(0571) 87774502

电邮：contact.ptcn@cn.bosch.com

www.bosch-pt.com.cn

罗伯特·博世有限公司

香港北角英皇道 625 号 21 楼

客户服务热线：+852 2101 0235

传真：+852 2590 9762

电邮：info@hk.bosch.com

网站：www.bosch-pt.com.hk

制造商地址：

Robert Bosch Power Tools GmbH

罗伯特·博世电动工具有限公司

70538 Stuttgart / GERMANY

70538 斯图加特 / 德国

处理废弃物

必须以符合环保的方式，回收再利用损坏的机器、附件和废弃的包装材料。



不可以把电动工具丢入家庭垃圾中！

保留修改权。

中文

電動工具通用安全警告

警告 閱讀所有警告和所有說明。不遵照以下警告和說明會導致電擊、著火和 / 或嚴重傷害。

保存所有警告和說明書以備查閱。

在所有下列的警告中術語“電動工具”指市電驅動（有線）電動工具或電池驅動（無線）電動工具。

工作場地的安全

- ▶ 保持工作場地清潔和明亮。混亂和黑暗的場地會引發事故。
- ▶ 不要在易爆環境，如有易燃液體、氣體或粉塵的環境下操作電動工具。電動工具產生的火花會點燃粉塵或氣體。
- ▶ 讓兒童和旁觀者離開後操作電動工具。注意力不集中會使你失去對工具的控制。

電氣安全

- ▶ 電動工具插頭必須與插座相配。絕不能以任何方式改裝插頭。需接地的電動工具不能使用任何轉換插頭。未經改裝的插頭和相配的插座將減少電擊危險。
- ▶ 避免人體接觸接地表面，如管道、散熱片和冰箱。如果你身體接地會增加電擊危險。
- ▶ 不得將電動工具暴露在雨中或潮濕環境中。水進入電動工具將增加電擊危險。
- ▶ 不得濫用電線。絕不能用電線搬運、拉動電動工具或拔出其插頭。使電線遠離熱源、油、銳邊或運動部件。受損或纏繞的軟線會增加電擊危險。
- ▶ 當在戶外使用電動工具時，使用適合戶外使用的外接軟線。適合戶外使用的軟線，將減少電擊危險。
- ▶ 如果在潮濕環境下操作電動工具是不可避免的，應使用剩餘電流動作保護器（RCD）。使用 RCD 可減小電擊危險。

人身安全

- ▶ 保持警覺，當操作電動工具時關注所從事的操作並保持清醒。當你感到疲倦，或在有藥物、酒精或治療反應時，不要操作電動工具。在操作電動工具時瞬間的疏忽會導致嚴重人身傷害。
- ▶ 使用個人防護裝置。始終佩戴護目鏡。安全裝置，諸如適當條件下使用防塵面具、防滑安全鞋、安全帽、聽力防護等裝置能減少人身傷害。
- ▶ 防止意外起動。確保開關在連接電源和 / 或電池盒、拿起或搬運工具時處於關斷位置。手指放在已接通電源的開關上或開關處於接通時插入插頭可能會導致危險。

- ▶ 在電動工具接通之前，拿掉所有調節鑰匙或扳手。遺留在電動工具旋轉零件上的扳手或鑰匙會導致人身傷害。
- ▶ 手不要伸展得太長。時刻注意立足點和身體平衡。這樣在意外情況下能很好地控制電動工具。
- ▶ 著裝適當。不要穿寬鬆衣服或佩戴飾品。讓你的衣服、手套和頭髮遠離運動部件。寬鬆衣服、佩飾或長髮可能會捲入運動部件中。
- ▶ 如果提供了與排屑、集塵設備連接用的裝置，要確保他們連接完好且使用得當。使用這些裝置可減少塵屑引起的危險。

電動工具使用和注意事項

- ▶ 不要濫用電動工具，根據用途使用適當的電動工具。選用適當設計的電動工具會使你工作更有效、更安全。
- ▶ 如果開關不能接通或關斷工具電源，則不能使用該電動工具。不能用開關來控制的電動工具是危險的且必須進行修理。
- ▶ 在進行任何調節、更換附件或貯存電動工具之前，必須從電源上拔掉插頭和/或使電池盒與工具脫開。這種防護性措施將減少工具意外起動的危險。
- ▶ 將閒置不用的電動工具貯存在兒童所及範圍之外，並且不要讓不熟悉電動工具或對這些說明不瞭解的人操作電動工具。電動工具在未經培訓的用戶手中是危險的。
- ▶ 保養電動工具。檢查運動件是否調整到位或卡住，檢查零件破損情況和影響電動工具運行的其他狀況。如有損壞，電動工具應在使用前修理好。許多事故由維護不良的電動工具引發。
- ▶ 保持切削刀具鋒利和清潔。保養良好的有鋒利切削刃的刀具不易卡住而且容易控制。
- ▶ 按照使用說明書，考慮作業條件和進行的作業來使用電動工具、附件和工具的刀頭等。將電動工具用於那些與其用途不符的操作可能會導致危險。

檢修

- ▶ 將你的電動工具送交專業維修人員，必須使用同樣的備件進行更換。這樣將確保所維修的電動工具的安全性。

針對線鋸的安全規章

- ▶ 如果安裝在此裝置上的切割配件可能會在作業期間割到隱藏的電線或自身的電源線，請務必從裝置握把上的絕緣處來握住該裝置。切割配件萬一接觸到帶電導線，可能會連帶使裝置上的金屬部件帶電，進而導致操作者觸電。

進一步的安全規章和工作指示

- ▶ 雙手必須遠離鋸割範圍，手不可以握在工件下端。如果不小心碰觸了鋸片可能被割傷。
- ▶ 先開動電動工具後再把工具放置在工件上切割。如果電動工具被夾在工件中，會有反擊的危險。
- ▶ 鋸割時必須把底座正確地放置在工件上。鋸片如果歪斜了，可能斷裂或者造成反擊。
- ▶ 工作告一段落時，必須先關閉電動工具並等待機器完全靜止後，才可以從鋸縫中拔出鋸刀。如此不但可以防止反擊，而且可以防止放置機器時發生危險。
- ▶ 只能使用未受損，功能正常的鋸片。彎曲或變鈍的鋸片可能斷裂，對鋸痕造成負面影響或導致反彈。
- ▶ 關機後不可以側壓刀片來制止仍然繼續轉動的刀片。鋸刀可能因此受損、斷裂或者造成反擊。
- ▶ 使用合適的偵測裝置偵察隱藏的電線，或者向當地的相關單位尋求支援。接觸電線可能引起火災並讓操作者觸電。損壞了瓦斯管會引起爆炸。鑿穿水管不僅會造成嚴重的財物損失，也可能導致觸電。
- ▶ 固定好工件。使用固定裝置或老虎鉗固定工件，會比用手持握工件更牢固。
- ▶ 等待電動工具完全靜止後才能夠放下機器。機器上的工具可能在工作中被夾住，而令您無法控制電動工具。
- ▶ 維修電動工具或換裝零、配件之前，務必從插座上拔出插頭。
- ▶ 鋸刀不可以比預定的鋸線長。在狹小的彎角上鋸割時要使用窄的鋸刀。
- ▶ 檢查鋸刀是否已經裝牢了。鬆動的鋸刀可能掉落並傷害您。
- ▶ 拋出鋸刀時千萬要握好電動工具，不可以讓彈出的鋸刀傷害旁人或動物。
- ▶ 含鉛的顏料以及某些木材、礦物和金屬的加工廢塵有害健康、可能造成過敏、讓操作者感染呼吸道疾病和/或癌症。只有經過專業訓練的人員才能夠加工含石棉的物料。
 - 工作場所要保持空氣流通。
 - 最好佩戴 P2 濾網等級的口罩。
 請留心並遵守貴國和加工物料有關的法規。
- ▶ 避免讓工作場所堆積過多的塵垢。塵埃容易被點燃。
- ▶ 注意電源的電壓！電源的電壓必須和電動工具銘牌上標示的電壓一致。
- ▶ 安裝在機殼上的防護把手（參考圖 12，頁數 39）能夠防止操作者意外地碰觸鋸刀，不可以拆除防護把手。
- ▶ 在木材、木屑夾板及建材上鋸割時必須檢查是否有隱藏的異物，例如釘子、螺釘等。必要時得清除異物。
- ▶ 進行潛鋸時必須挑選軟的物料，例如木材，石膏板等。
- ▶ 防毛邊壓板可以防止鋸割木材時，撕裂工件表面。

14 | 中文

- ▶ 根據用途適當地調整電動工具的設定。例如加工金屬和在狹窄的彎角上鋸割時，必須降低沖擊和振蕩擺動的次數。
- ▶ 在某些極端的操作環境下，如果可能的話一定要使用吸塵裝備。時常將通氣孔上累積的塵垢噴吹乾淨，並在前側加設漏電斷路器 (PRCD)。加工金屬時可能在電動工具的內部堆積會導電的廢塵。這樣可能會影響電動工具的安全絕緣性能。

代表符號

以下的符號可以幫助您正確地使用本機器。請詳細閱讀各符號及它們的代表意思。正確了解各符號所代表的意義，可以幫助您更有把握更安全地操作本機器。

符號	含義
	GST 25 M: 配備恆定電子裝備和弓形握柄的線鋸 打上灰色記號的部位：手柄 (絕緣的握持位置)
	閱讀所有的安全規章和說明
	在電動工具上進行任何修護工作之前必須從電源插座上拔出插頭
	佩戴防護手套
	附加資訊
	移動方向
	反應方向
	下一個處理步驟
	針對鋸屑的吹氣裝置
	小沖擊次數
	高沖擊次數
	開動

符號	含義
	關閉
	鎖定起停開關
	禁止的行為
	正確的結果
	鋸割金屬時必須沿著鋸割線塗抹冷卻劑或潤滑劑
	產品編號 (10 位數)
P_1	額定輸入功率
n_0	空載跳躍次數
	最大鋸割深度
	木材
	鋁板
	金屬
	重量符合 EPTA-Procedure 01:2014
	絕緣等級 II 的代表符號 (完全絕緣)

供貨範圍

線鋸。

防毛邊壓板，平行擋塊，片和其它被標示的或經過描述的附件並不包含在基本供貨範圍中。

在本公司的附件清單中標列了完整的附件。

按照規定使用機器

本機器可以在穩固的底墊上，進行切割、挖割。適用的材料包括木材、塑膠、金屬、陶片和橡膠等。本機器不僅能夠直鋸，也可以鋸彎角。請使用本公司推薦的鋸刀片。

技術性數據

本產品的技術數據列在本使用說明書 33 頁的表格中。

本說明書提供的參數是以 230 伏特為依據，於低電壓地區，此數據有可能不同。

安裝和操作

執行目的	圖片	頁數
安裝鋸刀	1	34
拋出鋸刀	2	34
開動吹氣裝置	3	35
安裝防毛邊壓板	4	35
調整振蕩功能	5	35
調整沖擊次數	6	36
開動 / 關閉	7	36
加工金屬時的潤滑工作	8	37
潛鋸	9	37
安裝遮蓋罩	10	37
安裝和使用平行擋塊	11	38
選擇附件	-	40 - 41

維修和清潔

- ▶ **電動工具，通氣孔以及工具接頭要隨時保持清潔，以確保能夠有把握且安全地操作電動工具。**

如果必須更換連接線，務必把這項工作交給博世或者經授權的博世電動工具顧客服務執行，以避免危害機器的安全性能。

定期清潔鋸刀接頭。此時必須先從電動工具中拆下鋸刀，並且在平坦的表面上輕敲電動工具，以便抖落污垢。

定期檢查導引輪 是否磨損了。如果確定導引輪已經損壞，必須把機器交給經過授權的博世客戶服務中心更換導引輪。

適時地使用 一滴油潤滑導引輪（參考圖 13，頁數 39）。

顧客服務處和顧客諮詢中心

本公司顧客服務處負責回答有關本公司產品的修理，維護和備件的問題。以下的網頁中有爆炸圖和備件的資料：

www.bosch-pt.com

博世顧客諮詢團隊非常樂意為您解答有關本公司產品及附件的問題。

當您需要諮詢或訂購備用零組件時，請務必提供本產品型號銘牌上的 10 位項目編號。

台灣

台灣羅伯特博世股份有限公司

建國北路一段 90 號 6 樓

台北市 10491

電話：(02) 2515 5388

傳真：(02) 2516 1176

www.bosch-pt.com.tw

製造商地址：

Robert Bosch Power Tools GmbH

羅伯特·博世電動工具有限公司

70538 Stuttgart / GERMANY

70538 斯圖加特 / 德國

處理廢棄物

必須以符合環保的方式，回收再利用損壞的機器、附件和廢棄的包裝材料。

 不可以把電動工具丟入家庭垃圾中。

保留修改權。

設備名稱：曲線鋸，型號：GST 25 M

限用物質及其符號

單元	鉛 (Pb)	汞 (Hg)	鎘 (Cd)	六價鉻 (Cr ⁺⁶)	多溴聯苯 (PBB)	多溴二苯醚 (PBDE)
開關	0	0	0	0	0	0
電容器	0	0	0	0	0	0
馬達	0	0	0	0	0	0
電源線	0	0	0	0	0	0
外殼（塑料）	0	0	0	0	0	0
外殼（金屬）	0	0	0	0	0	0
調速器	0	0	0	0	0	0

備考 1. "超出 0.1 wt %" 及 "超出 0.01 wt %" 係指限用物質之百分比含量超出 百分比含量基準值。

備考 2. "0" 係指該項限用物質之百分比含量未超出百分比含量基準值。

備考 3. "-" 係指該項限用物質為排除項目。

한국어

전동공구용 일반 안전수칙

⚠ 경고 모든 안전수칙과 지시 사항을 상세히 읽고 지켜야 합니다. 다음의 안전수칙과 지시 사항을 준수하지 않으면 화재 위험이 있으며 감전 혹은 중상을 입을 수 있습니다.

앞으로의 참고를 위해 이 안전수칙과 사용 설명서를 잘 보관하십시오.

다음에서 사용되는 “전동공구” 라는 개념은 전원에 연결하여 사용하는 전동 기기 (전선이 있는) 나 배터리를 사용하는 전동 기기 (전선이 없는) 를 의미합니다.

작업장 안전

- ▶ **작업장을 항상 깨끗이 하고 조명을 밝게 하십시오.** 작업장 환경이 어수선하거나 어두우면 사고를 초래할 수 있습니다.
- ▶ **가연성 유체, 가스 또는 분진이 있어 폭발 위험이 있는 환경에서 전동공구를 사용하지 마십시오.** 전동공구는 분진이나 증기에 점화하는 스파크를 일으킬 수 있습니다.
- ▶ **전동공구를 사용할 때 구경꾼이나 어린이 혹은 다른 사람이 작업장에 접근하지 못하게 하십시오.** 다른 사람이 주의를 산만하게 하면 기기에 대한 통제를 잃기 쉽습니다.

전기에 관한 안전

- ▶ **전동공구의 전원 플러그가 전원 콘센트에 잘 맞아야 합니다.** 플러그를 조금이라도 변경시켜서는 안됩니다. 접지된 전동공구를 사용할 때 어댑터 플러그를 사용하지 마십시오. 변형되지 않은 플러그와 잘 맞는 콘센트를 사용하면 감전의 위험을 감소할 수 있습니다.
- ▶ **파이프 관, 라디에이터, 레인지, 냉장고와 같은 접지 표면에 물이 닿지 않도록 하십시오.** 물에 닿을 경우 감전될 위험이 높습니다.
- ▶ **전동공구를 비에 맞지 않게 하고 습기 있는 곳에 두지 마십시오.** 전동공구에 물이 들어가면 감전될 위험이 높습니다.
- ▶ **전원 코드를 잡고 전동공구를 운반하거나 걸어 놓아서는 안되며, 콘센트에서 전원 플러그를 뽑을 때 전원 코드를 잡아 당겨서는 절대로 안됩니다.** 전원 코드가 열과 오일에 접촉하는 것을 피하고, 날카로운 모서리나 기기의 가동 부위에 닿지 않도록 주의하십시오. 손상되거나 영긴 전원 코드는 감전을 유발할 수 있습니다.
- ▶ **실외에서 전동공구로 작업할 때는 실외용으로 적당한 연장 전원 코드만을 사용하십시오.** 실외용 연장 전원 코드를 사용하면 감전의 위험을 줄일 수 있습니다.
- ▶ **전동공구를 습기 찬 곳에서 사용해야 할 경우에는 누전 차단기를 사용하십시오.** 누전 차단기를 사용하면 감전 위험을 줄일 수 있습니다.

사용자 안전

- ▶ **신중하게 작업하십시오.** 작업을 할 때 주의를 하며, 전동공구를 사용할 때 경솔하게 행동하지 마십시오. 피로한 상태이거나 약물 복용 및 음주한 후에는 전동공구를 사용하지 마십시오. 전동공구를 사용할 때 잠시라도 주위가 산만해지면 중상을 입을 수 있습니다.
- ▶ **작업자 안전을 위한 장치를 사용하십시오.** 항상 보안경을 착용하십시오. 전동공구의 종류와 사용에 따라 먼지 보호 마스크, 미끄러지지 않는 안전한 신발, 안전모 또는 귀마개 등의 안전한 복장을 하면 상해의 위험을 줄일 수 있습니다.
- ▶ **실수로 기기가 작동되지 않도록 주의하십시오.** 전동공구를 전원에 연결하거나 배터리를 끼우기 전에, 혹은 기기를 들거나 운반하기 전에, 전원 스위치가 꺼져 있는지 다시 확인하십시오. 전동공구를 운반할 때 전원 스위치에 손가락을 대거나 전원 스위치가 켜진 상태에서 전원을 연결하면 사고 위험이 높습니다.
- ▶ **전동공구를 사용하기 전에 조절하는 톨이나 나사 키 등을 빼 놓으십시오.** 회전하는 부위에 있는 톨이나 나사 키로 인해 상처를 입을 수 있습니다.
- ▶ **자신을 과신하지 마십시오.** 불안정한 자세를 피하고 항상 평형을 이룬 상태로 작업하십시오. 안정된 자세와 평형한 상태로 작업해야만이 의외의 상황에서도 전동공구를 안전하게 사용할 수 있습니다.
- ▶ **알맞은 작업복을 입으십시오.** 헐렁한 복장을 하거나 장신구를 착용하지 마십시오. 머리나 옷 또는 장갑이 가동하는 기기 부위에 가까이 닿지 않도록 주의하십시오. 헐렁한 복장, 장신구 혹은 긴 머리는 가동 부위에 말려 사고를 초래할 수 있습니다.
- ▶ **분진 추출장치나 수거장치의 조립이 가능한 경우, 이 장치가 연결되어 있는지, 제대로 작동이 되는지 확인하십시오.** 이러한 분진 추출장치를 사용하면 분진으로 인한 사고 위험을 줄일 수 있습니다.

전동공구의 올바른 사용과 취급

- ▶ **기기를 과부하 상태에서 사용하지 마십시오.** 작업할 때 이에 적당한 전동공구를 사용하십시오. 알맞은 전동공구를 사용하면 지정된 성능 한도 내에서 더 효율적으로 안전하게 작업할 수 있습니다.
- ▶ **전원 스위치가 고장 난 전동공구를 사용하지 마십시오.** 전원 스위치가 작동되지 않는 전동공구는 위험하므로, 반드시 수리를 해야 합니다.
- ▶ **기기에 세팅을 하거나 액세서리 부품을 교환하거나 혹은 기기를 보관할 때, 항상 전원 콘센트에서 플러그를 미리 빼어 놓으십시오.** 이러한 조치는 실수로 전동공구가 작동하게 되는 것을 예방합니다.
- ▶ **사용하지 않는 전동공구는 어린이 손이 닿지 않는 곳에 보관하고, 전동공구 사용에 익숙하지 않거나 이 사용 설명서를 읽지 않은 사람은 기기를 사용해서는 안됩니다.** 경험이 없는 사람이 전동공구를 사용하면 위험합니다.

- ▶ **전동공구를 조심스럽게 관리하십시오.** 가동 부위가 하나 없이 정상적인 기능을 하는지, 걸리는 부위가 있는지, 혹은 전동공구의 기능에 중요한 부품이 손상되지 않았는지 확인하십시오. 손상된 기기의 부품은 전동공구를 다시 사용하기 전에 반드시 수리를 맡기십시오. 제대로 관리하지 않은 전동공구의 경우 많은 사고를 유발합니다.
- ▶ **절단 공구를 날카롭고 깨끗하게 관리하십시오.** 날카로운 절단면이 있고 잘 관리된 절단공구는 걸리는 경우가 드물고 조절하기도 쉽습니다.
- ▶ **전동공구, 액세서리, 장착하는 공구 등을 사용할 때, 이 지시 사항과 특별히 기종 별로 나와있는 사용 방법을 준수하십시오.** 이때 작업 조건과 실시하려는 작업 내용을 고려하십시오. 원래 사용 분야가 아닌 다른 작업에 전동공구를 사용할 경우 위험한 상황을 초래할 수 있습니다.

서비스

- ▶ **전동공구 수리는 반드시 전문 인력에게 맡기고, 수리 정비 시 보쉬 순정 부품만을 사용하십시오.** 그렇게 함으로써 기기의 안전성을 오래 유지할 수 있습니다.

직소용 안전 수칙

- ▶ **작업할 때 톱날이 보이지 않는 전선이나 기기 자체의 코드에 닿을 위험이 있으면 전동공구의 절연된 손잡이 면을 잡으십시오.** 전류가 흐르는 전선에 접하게 되면 기기의 금속 부위에도 전기가 통해 감전될 위험이 있습니다.

기타 안전수칙 및 사용방법

- ▶ **절단 부위에 손을 가까이 대지 마십시오.** 작업물의 아래쪽을 잡지 마십시오. 날과 접하게 되면 상해를 입을 수 있습니다.
- ▶ **전동공구를 켜 상태에서만 작업물에 서서히 접근하십시오.** 그렇지 않으면 톱날이 작업물에 걸리면서 반동이 생길 위험이 있습니다.
- ▶ **절단작업을 할 때 밀판 이 완전히 작업물에 놓여 있는지 확인하십시오.** 톱날이 걸려 있으면 부러지거나 반동이 생길 수 있습니다.
- ▶ **작업을 마치고 나서 전동공구의 스위치를 끄고 기기가 완전히 정지된 후에 절단면에서 톱날을 빼십시오.** 이렇게 하면 반동이 생기는 것을 방지할 수 있으며 전동공구를 안전하게 내려 놓을 수 있습니다.
- ▶ **반드시 손상되지 않은 하자 없는 톱날만을 사용하십시오.** 휘거나 날카롭지 않은 톱날이 부러져 절단에 지장을 주거나 반동을 유발할 수 있습니다.
- ▶ **스위치를 끄고 나서 톱날을 옆에서 돌려 정지해서는 안 됩니다.** 이로 인해 톱날이 손상되거나 부러질 수 있으며 혹은 반동을 유발할 수 있습니다.

- ▶ **보이지 않는 배관 설비를 확인하려면 적당한 탐지기를 사용하거나 담당 에너지 공급회사에 문의하십시오.** 전선에 접하게 되면 화재나 전기 충격을 야기할 수 있습니다. 가스관을 손상시키면 폭발 위험이 있습니다. 수도관을 파손하게 되면 재산 피해를 유발하거나 전기 충격을 야기할 수 있습니다.
- ▶ **작업물을 잘 고정하십시오.** 고정장치나 기계 바이스에 끼워서 작업하면 손으로 잡는 것보다 더 안전합니다.
- ▶ **전동공구를 내려놓기 전에 기기가 완전히 멈추었는지를 확인하십시오.** 벨트가 걸려 전동공구에 대한 통제가 어려워질 수 있습니다.
- ▶ **전동공구를 보수 정비하기 전에 반드시 콘센트에서 전원 플러그를 빼십시오.**
- ▶ **톱날은 절단하려는 깊이보다 길어서는 안됩니다.** 좁은 모서리 절단 시 가는 톱날을 사용하십시오.
- ▶ **톱날이 제대로 끼워졌는지 확인해 보십시오.** 느슨하게 걸린 톱날은 빠질 수 있으며 이로 인해 작업자가 상해를 입을 수 있습니다.
- ▶ **톱날을 뺄 때 빠지는 톱날로 인해 사람이나 동물이 다치지 않도록 하여 전동공구를 잡으십시오.**
- ▶ **납 성분을 함유한 페인트나 몇몇 목재 종류, 광물 및 금속 등 소재의 분진은 건강에 유해할 수 있으며 알레르기 반응이나 호흡기 질환 그리고 / 혹은 암을 유발할 수 있습니다.** 석면을 함유한 소재는 위험하므로 전문 인력들만 작업해야 합니다.
 - 작업장의 통풍이 잘 되도록 하십시오.
 - 필터등급 P2가 장착된 호흡 마스크를 사용하십시오. 작업용 재료에 관해 국가가 지정한 규정을 고려 하십시오.
- ▶ **작업장에 분진이 쌓이지 않도록 하십시오.** 분진이 쉽게 발화할 수 있습니다.
- ▶ **공공 배전 전압에 주의!** 공급되는 전원의 전압은 전동공구의 명판에 표기된 전압과 동일해야 합니다.
- ▶ **기기 몸체에 달려 있는 안전 핀(39 면, 그림 12 참조)은 작업 도중에 실수로 톱날에 접하게 되는 것을 방지하므로 빼서는 안됩니다.**
- ▶ **목재, 파티클 보드, 건축용 소재 등에 절단작업을 할 경우 못이나 나사같은 이물질이 없는지 확인하고, 있으면 먼저 이를 제거해야 합니다.**
- ▶ **삼입 절단작업(플런지 컷)은 목재나 석고 보드 등과 같은 연질의 재료에만 가능합니다.**
- ▶ **작업 표면 보호대는 목재 절단작업 시표면에 가시같은 부스러기가 생기는 것을 방지합니다.**
- ▶ **귀하가 원하는 작업에 따라 전동공구의 설정을 조절하여 주십시오.** 예를 들면 금속 절단이나 목재 곡선 절단 시 공구의 속도와 오비탈 속도를 저속으로 맞추어야 합니다.











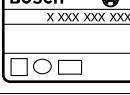

18 | 한국어

▶ 열악한 환경에서 작업할 경우 가능한 한 추출장치를 항상 사용하도록 하십시오. 통풍구를 자주 청소하고 누전 차단기 (PRCD) 에 연결하십시오. 금속 소재에 작업할 경우 전도성 분진이 전동공구 안에 쌓이게 되면 전동공구의 보호 절연장치 기능에 장애가 생길 수 있습니다.

기호

다음에 나와있는 기호는 사용 설명서를 읽고 이해하는 데 중요합니다. 그러므로 기호와 그 의미를 잘 기억하십시오. 기호를 제대로 이해하면 전동공구를 더욱 쉽고 안전하게 사용할 수 있습니다.

기호	의미
	GST 25 M: 일정속도 전자 제어 장치와 곡선 핸들이 있는 직소 회색 표시 부위: 손잡이 (절연 손잡이)
	모든 안전 수칙과 지시 사항을 읽으십시오
	전동공구에 작업하기 전에 반드시 전원 콘센트에서 플러그를 빼십시오
	보호 장갑을 착용하십시오
	추가 정보
	이동 방향
	반동 방향
	다음 단계
	톱밥 분출장치
	저속
	고속
	스위치 켜기
	스위치 끄기

기호	의미
	전원 스위치 고정하기
	금지 사항
	올바른 결과
	금속 절단작업을 할 경우 절단선을 따라 냉각제나 윤활제를 바르십시오
	제품 번호 (10 자리)
	소비 전력
	무부하 속도
	최대 절단 깊이
	목재
	알루미늄
	금속
	EPTA 공정 01:2014 에 따른 중량
	안전등급 표시 II (완전히 절연됨)

공급 내역

직소.
작업 표면 보호대, 평형 가이드, 톱날 등 도면이나 설명서에 나와있는 액세서리는 표준 공급부품에 속하지 않습니다.
전체 액세서리는 본사 액세서리 프로그램을 참고하십시오.

규정에 따른 사용

본 전동공구는 목재 플라스틱 금속 세라믹판 그리고 고무를 단단한 작업대 위에 고정시킨 상태에서 절단작업과 절단선을 긋는 작업을 하는데 사용해야 합니다. 직선 및 곡선형 절단에 적합합니다. 톱날 선택에 있어 권장 자료를 참조하십시오.

제품 사양

제품의 제품 사양은 본 사용 설명서의 33 페이지의 도표에 나와있습니다.
자료는 정격 전압 [U] 230 V 를 기준으로 한 것입니다. 전압이 낮거나 각국의 특수한 모델에 따라 달라질 수 있습니다.

조립 및 작동

작업 내용	그림	페이지
톱날 끼우기	1	34
톱날 빠기	2	34
분진 추출장치 작동하기	3	35
작업 표면 보호대 조립하기	4	35
오비탈 작동 조절하기	5	35
속도 설정 조절하기	6	36
전원 스위치 작동하기	7	36
금속 작업 시 윤활하기	8	37
삽입 절단작업 (플런지 컷)	9	37
덮개의 조립	10	37
평형 가이드의 조립 및 사용	11	38
액세서리 선택하기	-	40-41

보수 정비 및 유지

▶ **효율적으로 안전한 작업을 위해 전동공구 및 통풍구 그리고 톱날 홀더를 항상 깨끗이 유지하십시오.**

연결 코드를 교환해야 할 경우 안전을 기하기 위해 보쉬 사나 보쉬 지정 전동공구 서비스 센터에 맡겨야 합니다.

톱날 홀더를 정기적으로 닦아 주십시오. 이 경우 톱날을 전동공구에서 빼내고 전동공구를 평면에 가볍게 두드려 털어 주십시오.

가이드 롤러를 정기적으로 마모되지 않았는지 확인하십시오. 마모된 경우, 보쉬 지정 서비스 센터에 맡겨 교환해 주어야 합니다.

가이드 롤러에 가끔 오일 한 방울을 발라 주십시오 (39 면, 그림 13 참조).

보쉬 AS 및 고객 상담

보쉬는 귀하의 제품 및 수리에 관한 문의를 받고 있습니다.

AS 센터 정보 및 제품에 대한 고객 상담은 하기 고객 콜센터 및 이메일 상담을 이용해주시기 바랍니다.

고객 콜센터 : 080-955-0909

이메일 상담 :

Bosch-pt.hotline@kr.bosch.com

문의나 대체 부품 주문 시에는 반드시 제품 네임 플레이트에 있는 10 자리의 부품번호를 알려 주십시오.

Bosch Korea, RBKR
Mechanics and Electronics Ltd.
PT/SAX-ASA
298 Bojeong-dong Giheung-gu
Yongin-si, Gyeonggi-do, 446-913
080-955-0909

처리

기기와 액세서리 및 포장 등은 친환경적인 방법으로 재활용할 수 있도록 분류하십시오.



전동공구를 가정용 쓰레기로 처리하지 마십시오!

위 사항은 사전 예고 없이 변경될 수도 있습니다.

ภาษาไทย

คำเตือนทั่วไปเพื่อความปลอดภัยในการใช้เครื่องมือไฟฟ้า

⚠ คำเตือน ต้องอ่านคำเตือนเพื่อความปลอดภัยและคำสั่งทั้งหมด การไม่ปฏิบัติตามคำเตือนและคำสั่งอาจเป็นสาเหตุให้ถูกไฟฟ้าดูด เกิดไฟไหม้ และ/หรือได้รับบาดเจ็บอย่างร้ายแรง

เก็บรักษาคำเตือนและคำสั่งทั้งหมดสำหรับเปิดอ่านในภายหลัง

คำว่า "เครื่องมือไฟฟ้า" ในคำเตือนหมายถึง เครื่องมือไฟฟ้าของท่านที่ทำงานด้วยพลังงานไฟฟ้าที่ต่อจากเต้าเสียบ (มีสายไฟฟ้า) และเครื่องมือไฟฟ้าที่ทำงานด้วยพลังงานไฟฟ้าจากแบตเตอรี่ (ไร้สาย)

ความปลอดภัยในสถานที่ทำงาน

- ▶ **รักษาสถานที่ทำงานให้สะอาดและมีไฟส่องสว่างดี** สถานที่ที่มีมืดหรือกรงจิ้งจกนำมาซึ่งอุบัติเหตุ
- ▶ **อย่าใช้เครื่องมือไฟฟ้าในสภาพแวดล้อมที่เสี่ยงต่อการติดระเบิดได้ เช่น ในที่มีขมิ้นของเหลว แก๊ส หรือฝุ่นที่ติดไฟได้** เมื่อใช้เครื่องมือไฟฟ้าจะเกิดประกายไฟซึ่งอาจจุดฝุ่นหรือไอให้ลุกเป็นไฟได้
- ▶ **ขณะใช้เครื่องมือไฟฟ้าทำงาน ต้องกันเด็กและผู้ยืมดู** ให้ออกห่าง การหันเหความสนใจอาจทำให้ท่านขาดการควบคุมเครื่องได้

ความปลอดภัยเกี่ยวกับไฟฟ้า

- ▶ **ปลั๊กของเครื่องมือไฟฟ้าต้องมีขนาดพอดีกับเต้าเสียบ** อย่าตัดแปลงหรือแก้ไขตัวปลั๊กอย่างเด็ดขาด อย่าต่อปลั๊กต่อใดๆ เข้ากับเครื่องมือไฟฟ้าที่มีสายดิน ปลั๊กที่ไม่ตัดแปลงและเต้าเสียบที่เข้ากันช่วยลดความเสี่ยงจากการถูกไฟฟ้าดูด
- ▶ **หลีกเลี่ยงไม่ให้ร่างกายสัมผัสกับพื้นผิวของสิ่งของที่ต่อสายดินไว้ เช่น ท่อ เครื่องทำความร้อน เตา และตู้เย็น** จะเสี่ยงอันตรายจากการถูกไฟฟ้าดูดมากขึ้นหากกระแสไฟฟ้าวิ่งผ่านร่างกายของท่านลงดิน

20 | ภาษาไทย

- ▶ **อย่าวางเครื่องมือไฟฟ้าคาบฝนหรือทิ้งไว้ในที่ชื้นและ** หากน้ำเข้าในเครื่องมือไฟฟ้า จะเพิ่มความเสี่ยงจากการถูกไฟฟ้าดูด
- ▶ **อย่าใช้สายไฟฟ้าอย่างผิดๆ อย่าถือเครื่องมือไฟฟ้าที่สาย** อย่าใช้สายเชวนเครื่อง หรือยาดึงสายไฟฟ้าเพื่อถอดปลั๊กออกจากเต้าเสียบ กันสายไฟฟ้าออกห่างจากความร้อน น้ำมัน ขอบแหลมคม หรือส่วนของเครื่องมือที่กำลังเคลื่อนไหว สายไฟฟ้าที่ชำรุดหรือพันกันยุ่ง เพิ่มความเสี่ยงจากการถูกไฟฟ้าดูด
- ▶ **เมื่อใช้เครื่องมือไฟฟ้าทำงานกลางแจ้ง ให้ใช้สายไฟ** ต่อที่ได้รับการรับรองให้ใช้ต่อในที่กลางแจ้งเท่านั้น การใช้สายไฟต่อที่เหมาะสมสำหรับงานกลางแจ้งช่วยลดอันตรายจากการถูกไฟฟ้าดูด
- ▶ **หากไม่สามารถหลีกเลี่ยงการใช้เครื่องมือไฟฟ้าทำงาน** ในสถานที่เปียกชื้นได้ ให้ใช้สวิตช์ตัดวงจรเมื่อเกิดการรั่วไหลของไฟฟ้าจากสายดิน การใช้สวิตช์ตัดวงจรเมื่อเกิดการรั่วไหลของไฟฟ้าจากสายดินช่วยลดความเสี่ยงต่อการถูกไฟฟ้าดูด

ความปลอดภัยของคุณ

- ▶ **ท่านต้องอยู่ในสภาพเตรียมพร้อม ระวังระวังในสิ่งที่กำลังทำอยู่ และมีสติขณะใช้เครื่องมือไฟฟ้าทำงาน** อย่าใช้เครื่องมือไฟฟ้าขณะที่ท่านกำลังเหนื่อย หรืออยู่ภายใต้การครอบงำของฤทธิ์ของยาเสพติด แอลกอฮอล์ และยา เมื่อใช้เครื่องมือไฟฟ้าทำงาน ในชั่วนาทีที่ท่านขาดความเอาใจใส่อาจทำให้บุคคลบาดเจ็บอย่างรุนแรงได้
- ▶ **ใช้อุปกรณ์ป้องกันร่างกาย สวมแว่นตาป้องกันเสมอ** อุปกรณ์ปกป้อง เช่น หน้ากากกันฝุ่น รองเท้ากันลื่น หมวกแข็ง หรือประภททุกชิ้นเสียงดัง ที่เลือกใช้ตามความเหมาะสมกับสภาพการทำงาน สามารถลดอันตรายต่อบุคคลได้
- ▶ **ป้องกันการติดเครื่องโดยไม่ตั้งใจ ต้องดูให้แน่ใจว่า** สวิตช์อยู่ในตำแหน่งปิดก่อนเสียบปลั๊กไฟเข้าในเต้าเสียบ และ/หรือ ใส่แท่งแบตเตอรี่ ยักษ์หรือถือเครื่องมือ การถือเครื่องโดยใช้นิ้วหัวที่สวิตช์ หรือเสียบพลังไฟฟ้าขณะสวิตช์เปิดอยู่ อาจนำไปสู่อุบัติเหตุที่ร้ายแรงได้
- ▶ **เอาเครื่องมือปรับแต่งหรือประแจจากตายนอกจาก** เครื่องมือไฟฟ้าก่อนเปิดสวิตช์ เครื่องมือหรือประแจปากตายนี้อาจอยู่กับส่วนของเครื่องมือที่กำลังหมุนจะทำให้บุคคลบาดเจ็บได้
- ▶ **หลีกเลี่ยงการตั้งท่าที่ผิดปกติ ตั้งท้ายที่นั่งคนและ** วางน้ำหนักให้สมดุลตลอดเวลา ในลักษณะนี้ท่านสามารถควบคุมเครื่องมือไฟฟ้าในสถานการณ์ที่ไม่คาดคิดได้ดีกว่า

- ▶ **ใส่เสื้อผ้าที่เหมาะสม อย่าใส่เสื้อผ้าหลวมหรือสวม** เครื่องประดับ เอามม เสื้อผ้า และถุงมืออกห่างส่วนของเครื่องมือที่กำลังหมุน เสื้อผ้าหลวม เครื่องประดับ และผมยาวอาจเข้าไปติดในส่วนของเครื่องมือที่กำลังหมุนได้
- ▶ **หากต้องต่อเครื่องมือไฟฟ้าเข้ากับเครื่องดูดฝุ่นหรือ** เครื่องเก็บผง ดูให้แน่ใจว่าการเชื่อมต่อและการใช้งานเป็นไปอย่างถูกต้อง การใช้อุปกรณ์ดูดฝุ่นช่วยลดอันตรายที่เกิดจากฝุ่นได้

การใช้และการดูแลรักษาเครื่องมือไฟฟ้า

- ▶ **อย่าใช้เครื่องมือไฟฟ้าอย่างหักโหม ใช้เครื่องมือไฟฟ้า** ที่ถูกต้องตรงตามลักษณะงาน เครื่องมือไฟฟ้าที่ถูกต้องจะทำงานได้ดีกว่าและปลอดภัยกว่าในระดับสมรรถภาพที่ออกแบบไว้
- ▶ **อย่าใช้เครื่องมือไฟฟ้าที่สวิตช์เปิดปิดเสีย** เครื่องมือไฟฟ้าที่ไม่สามารถควบคุมการเปิดปิดด้วยสวิตช์ได้ เป็นเครื่องมือไฟฟ้าที่ไม่ปลอดภัยและต้องส่งซ่อมแซม
- ▶ **ก่อนปรับแต่งเครื่อง เปลี่ยนอุปกรณ์ประกอบ หรือ** เก็บเครื่องเข้าที่ ต้องถอดปลั๊กไฟออกจากเต้าเสียบ และ/หรือถอดแท่งแบตเตอรี่ออกจากเครื่องมือไฟฟ้า มาตรการป้องกันเพื่อความปลอดภัยนี้ช่วยลดความเสี่ยงจากการติดเครื่องโดยไม่ตั้งใจ
- ▶ **เมื่อเลิกใช้งานเครื่องมือไฟฟ้า ให้เก็บเครื่องมือในที่ที่** เด็กหยิบไม่ถึง และไม่อนุญาตให้บุคคลที่ไม่คุ้นเคยกับเครื่องหรือบุคคลที่ไม่ได้อ่านคำแนะนำนำผู้ใช้เครื่องมือไฟฟ้าเป็นของอันตรายหากตกอยู่ในมือของผู้ใช้ที่ไม่ได้รับการฝึกฝน
- ▶ **เอาใจใส่ดูแลรักษาเครื่อง ตรวจสอบหาส่วนที่เคลื่อนไหวย** ได้ของเครื่องว่าวางอยู่ตรงแนวหรือติดขัดหรือไม่ ตรวจสอบการแตกหักของชิ้นส่วนและสภาพอื่นใดที่อาจมีผลต่อการทำงานของเครื่องมือไฟฟ้า หากชำรุดต้องส่งเครื่องมือไฟฟ้าซ่อมแซมก่อนใช้งาน อุบัติเหตุหลายอย่างเกิดขึ้นเนื่องจากดูแลรักษาเครื่องไม่ดีพอ
- ▶ **รักษาเครื่องมือตัดให้คมและสะอาด** หากบำรุงรักษาเครื่องมือที่มีขอบตัดแหลมคมอย่างถูกต้อง จะสามารถตัดได้ลื่นไม่ติดขัดและควบคุมได้ง่ายกว่า
- ▶ **ใช้เครื่องมือไฟฟ้า อุปกรณ์ประกอบ เครื่องมือ และ** อุปกรณ์อื่นๆ ให้ตรงตามคำแนะนำนี้ และในลักษณะตามที่เครื่องมือไฟฟ้าประเภทนั้นๆ กำหนดไว้ โดยต้องคำนึงถึงเงื่อนไขการทำงานและงานที่จะทำด้วย การใช้เครื่องมือไฟฟ้าทำงานที่ต่างไปจากวัตถุประสงค์การใช้งานของเครื่อง อาจนำไปสู่สถานการณ์ที่เป็นอันตรายได้

การบริการ

- ▶ ส่งเครื่องมือไฟฟ้าให้ช่างผู้เชี่ยวชาญตรวจสอบและใช้อะไหล่เปลี่ยนของแท้เท่านั้น ในลักษณะนี้ท่านจะแน่ใจได้ว่าเครื่องมือไฟฟ้าอยู่ในสภาพที่ปลอดภัย

คำเตือนเพื่อความปลอดภัยสำหรับเลื่อยฉลุ

- ▶ เมื่อทำงานในบริเวณที่อุปกรณ์ตัดอาจสัมผัสกับสายไฟฟ้าที่ซ่อนอยู่หรือสายไฟฟ้าของเครื่อง ต้องจับเครื่องมือไฟฟ้าตรงตามจับที่หุ้มฉนวน หากอุปกรณ์ตัดสัมผัสกับสายที่มีกระแสไฟฟ้าไหลผ่านจะทำให้ส่วนที่เป็นโลหะของเครื่องมือไฟฟ้าเกิดมีกระแสไฟฟ้าด้วย และส่งผลให้ผู้ใช้เครื่องถูกไฟฟ้ากระตุกได้

วิธีปฏิบัติงานและคำแนะนำเพื่อความปลอดภัยเพิ่มเติม

- ▶ เามือออกจากบริเวณแนวเลื่อย อย่าเอื้อมมือเข้าได้ชิ้นงาน การสัมผัสกับใบเลื่อยจะทำให้บาดเจ็บได้
- ▶ จับเครื่องเข้าหาชิ้นงานเมื่อเครื่องเปิดทำงานอยู่เท่านั้น มิฉะนั้นอาจได้รับอันตรายจากการตีกลับหากเครื่องมือตัดติดขัดอยู่ในชิ้นงาน
- ▶ ขณะเลื่อย ดูให้แน่ใจว่าได้วางแผ่นฐาน ไรบนชิ้นงานอย่างมั่นคงแล้ว ใบเลื่อยที่ติดขัดอาจแตกหัก หรือทำให้เกิดการตีกลับได้
- ▶ เมื่อเสร็จงานตัด ให้ปิดสวิตช์เครื่อง และดึงใบเลื่อยออกจากร่องตัดเมื่อใบเลื่อยหยุดนิ่งอยู่กับที่แล้วเท่านั้น ในลักษณะนี้ท่านสามารถหลีกเลี่ยงการตีกลับ และวางเครื่องลงได้อย่างปลอดภัย
- ▶ ใช้เฉพาะ ใบเลื่อยที่ไม่ชำรุดและ ไม่มีตำหนิเท่านั้น ใบเลื่อยที่ทื่อหรือบิดงอสามารถแตกหัก ส่งผลเชิงลบต่อการตัด หรือทำให้เกิดการตีกลับได้
- ▶ เมื่อปิดสวิตช์เครื่องแล้ว อย่าเบรคใบเลื่อยให้หยุดวิ่งโดยการกดลงด้านข้าง ใบเลื่อยอาจชำรุด แตกหัก หรือทำให้เกิดการตีกลับได้
- ▶ ใช้เครื่องตรวจที่เหมาะสมตรวจหาท่อ สายไฟฟ้า หรือสายโทรศัพท์ ที่อาจซ่อนอยู่ในบริเวณที่ทำงาน หรือขอความช่วยเหลือจากบริษัทสาธารณูปโภคในท้องถิ่น การสัมผัสกับสายไฟฟ้าอาจทำให้เกิดไฟไหม้หรือถูกไฟฟ้าดูด การทำให้ท่อแก๊ซเสียหายอาจทำให้เกิดระเบิด การเจาะเข้าในท่อน้ำทำให้ทรัพย์สินเสียหาย หรืออาจเป็นเหตุให้ถูกไฟฟ้าดูดได้

- ▶ ยึดชิ้นงานให้แน่น การยึดชิ้นงานด้วยเครื่องหนีบหรือแท่นจับจะมั่นคงกว่าการยึดด้วยมือ
- ▶ ก่อนวางเครื่องลงบนพื้นทุกครั้งต้องรอให้เครื่องหยุดนิ่งอยู่กับที่เสมอ มิฉะนั้นเครื่องมือที่ใส่อยู่อาจติดขัดและนำไปสู่การสูญเสียการควบคุมเครื่องมือไฟฟ้า
- ▶ ดึงปลั๊กไฟออกจากเต้าเสียบก่อนปรับแต่งเครื่อง
- ▶ ใบเลื่อยควรมีขนาดยาวกว่าความหนาการตัดที่ต้องการ เพียงเล็กน้อยเท่าที่จำเป็น ใช้ใบเลื่อยหน้าแคบสำหรับการการตัดโค้งแคบ
- ▶ ตรวจสอบให้ใบเลื่อยเข้าที่อย่างมั่นคง ใบเลื่อยที่ใส่ไว้หลวมๆ อาจหลุดออกมาและทำให้บาดเจ็บได้
- ▶ เมื่อต้องการตัดใบเลื่อยออก ให้จับเครื่องในลักษณะที่เมื่อใบเลื่อยดีดออกมาจะไม่ทำให้บุคคลและสัตว์บาดเจ็บได้
- ▶ ผู้คนที่ได้จากวัสดุ เช่น เคลือบผิวที่มีตะกั่ว ไม้บางประเภท แร่ธาตุ และโลหะ อาจเป็นอันตรายต่อสุขภาพและทำให้เกิดอาการแพ้ นำไปสู่โรคติดเชื้อในระบบหายใจ และ/หรือโรคกระเพาะ ผู้ทำงานกับวัสดุผสมแอสเบสตอสได้ต้องเป็นช่างผู้เชี่ยวชาญเท่านั้น
 - จัดสถานที่ทำงานให้มีการระบายอากาศที่ดี
 - ขอแนะนำให้สวมหน้ากากป้องกันโรคติดเชื้อที่มีระดับ-ได้กรอง P2
 ปฏิบัติตามกฎหมายบังคับสำคัญอื่นๆ ที่เกี่ยวกับวัสดุชิ้นงานที่บังคับใช้ในประเทศของท่าน
- ▶ ป้องกันการสะสมของฝุ่นในสถานที่ทำงาน ฝุ่นสามารถถูกใหม่อย่างง่ายดาย
- ▶ ให้สังเกตแรงดันไฟฟ้า! แรงดันไฟฟ้าจากแหล่งจ่ายไฟฟ้าต้องมีค่าตรงกับค่าแรงดันไฟฟ้าที่ระบุไว้บนแผ่นป้ายพิกัดเครื่อง
- ▶ อุปกรณ์ป้องกันการสัมผัสที่ติดอยู่กับตัวเรือนเครื่อง (ดูภาพประกอบ 12 หน้า 39) ช่วยป้องกันการเตะจับใบเลื่อยโดยไม่ตั้งใจในระหว่างขั้นตอนการทำงาน และต้องไม่ถอดอุปกรณ์นี้ออก
- ▶ ก่อนเลื่อยในไม้ แผ่นชิ้นไม้อัด วัสดุก่อสร้าง และอื่นๆ ให้ตรวจหาสิ่งแปลกปลอม เช่น ตะปู สกรู และอื่นๆ และหากจำเป็นให้ถอนสิ่งแปลกปลอมนั้นออกไป
- ▶ การจ้วงตัดใช้ได้กับวัสดุเนื้ออ่อน เช่น ไม้ แผ่นยิปซัม และอื่นๆ เท่านั้น
- ▶ แผ่นป้องกันการฉีกที่ผิววัสดุสามารถป้องกันไม่ให้พื้นผิวสูญเสียเมื่อเลื่อยไม้
- ▶ ปรับการตั้งของเครื่องมือไฟฟ้าของท่านให้เหมาะสมกับการใช้งานแต่ละประเภท ตัวอย่าง เช่น ลดอัตราชักขึ้นลงและการเตะเมื่อตัดโลหะหรือตัดโค้งแคบ

22 | ภาษาไทย

- ▶ หากใช้เครื่องทำงานหนัก ให้ใช้อุปกรณ์คุ้มครองความปลอดภัยที่จะทำได้เสมอ เป้าของระบบระบายอากาศบ่อยๆ และติดตั้งอุปกรณ์ตัดวงจรเมื่อเกิดการรั่วไหลของไฟฟ้าลงดิน แบบพกพา (PRCD) เมื่อทำงานกับโลหะ ผุ่นซึ่งมีคุณสมบัตินำความร้อนและกระแสไฟฟ้าอาจสะสมอยู่ข้างในเครื่องมือไฟฟ้า ฉนวนป้องกันทั้งหมดของเครื่องมือไฟฟ้าอาจได้รับผลเสีย

สัญลักษณ์

สัญลักษณ์ต่อไปนี้มีความสำคัญต่อการอ่านและการทำความเข้าใจคู่มือการใช้งานเครื่อง กรุณาจดจำสัญลักษณ์และความหมายของสัญลักษณ์ การแปลความสัญลักษณ์ได้ถูกต้องจะช่วยให้ท่านใช้เครื่องได้ดีและปลอดภัยกว่า

สัญลักษณ์	ความหมาย
	GST 25 M: เลื่อยจลที่มีระบบควบคุมอิเล็กทรอนิกส์คงที่ และตามจับโค้ง
	บริเวณเลืหา: ตามจับ (พื้นผิวจับหุ้มด้วยฉนวน) ต้องอ่านค่าเตือนเพื่อความปลอดภัยและคำสั่งทั้งหมด
	ดึงปลั๊กไฟออกจากเต้าเสียบก่อนปรับแต่งเครื่อง
	ต้องสวมถุงมือป้องกัน
	ข้อมูลเพิ่มเติม
	ทิศทางการเคลื่อนที่
	ทิศทางการตอบสนอง
	ขั้นตอนการกระทำต่อไป
	เครื่องเป่าซีลีย
	อัตราชักขึ้นลง ต่ำ
	อัตราชักขึ้นลง สูง

สัญลักษณ์	ความหมาย
	เปิดเครื่องทำงาน
	ปิดเครื่อง
	สวิตช์เปิด-ปิด ล็อคไว้
	การกระทำที่ห้าม
	ผลที่ถูกต้อง
	เมื่อเลื่อยโลหะ ให้ชโลมสารหล่อเย็น/น้ำมันหล่อลื่นตามรอยตัด
	หมายเลขสินค้า (10 หลัก)
P_1	กำลังไฟฟ้าเข้ากำหนด
n_0	อัตราชักขึ้นลง เดินตัวเปล่า
	ความสามารถในการเลื่อย สูงสุด
	ไม่มี
	อะลูมิเนียม
	โลหะ
	นำหนักตามระเบียบการ-EPTA-Procedure 01:2014
	สัญลักษณ์สำหรับระดับความปลอดภัย II (ห่อหุ้มด้วยฉนวนทั้งหมด)

รายการสิ่งของที่จัดส่ง

เลื่อยจล

แผ่นป้องกันการฉีกที่ผิววัสดุ ตัวนำเลื่อยแบบขนาน เครื่องมือและอุปกรณ์ประกอบอื่นๆ ที่แสดงหรือบรรยาย ไม่รวมอยู่ในการจัดส่งมาตรฐาน

กรุณาดูการอธิบายโดยสรุปทั้งหมดในโปรแกรมอุปกรณ์ประกอบของเรา

ประโยชน์การใช้งานของเครื่อง

เครื่องนี้ใช้สำหรับตัดไม้ พลาสติก โลหะ แผ่นเซรามิก และยาง เพื่อแยกส่วนออกจากกันและเพื่อตัดออก โดยต้องวางเครื่องอย่างมั่นคงลงบนชิ้นงาน เครื่องนี้เหมาะสำหรับตัดแนวตรงและตัดรูปโค้ง อ่านและปฏิบัติตามคำแนะนำที่เกี่ยวข้องกับใบเลื่อย

ข้อมูลทางเทคนิค

ข้อมูลทางเทคนิคของเครื่องได้ลงรายการไว้ในตารางหน้า 33 ของคู่มือการใช้งานเครื่องเล่มนี้

ค่าที่เห็นใช้ได้กับแรงดันไฟฟ้าระบุ [U] 230 โวลต์ ค่าเหล่านี้ อาจผิดแผกไปสำหรับแรงดันไฟฟ้าที่ต่ำกว่า และโมเดลที่สร้าง สำหรับเฉพาะประเทศ

การประกอบและการปฏิบัติงาน

ขั้นตอน	ภาพประกอบ	หน้า
การใส่ไม้เลื่อย	1	34
การตัดไม้เลื่อยออก	2	34
การเปิดสวิตช์เครื่องเข้าซี่เลื่อย	3	35
การประกอบแผ่นป้องกัน		
การฉีกที่ผิววัสดุ	4	35
การตั้งการเตะ	5	35
การปรับการเลือกล่วงหน้า		
อัตราชักขึ้นลง	6	36
การเปิดและปิดสวิตช์	7	36
การหล่อลื่นเมื่อตัดโลหะ	8	37
การจ้วงตัด	9	37
การประกอบฝาครอบกันฝุ่น	10	37
การประกอบและการใช้		
ตัวนำเลื่อยแบบขนาน	11	38
การเลือกอุปกรณ์ประกอบ	-	40-41

การบำรุงรักษาและ การทำความสะอาด

- เพื่อการทำงานที่ถูกต้องและปลอดภัย ต้องรักษา เครื่อง และช่องระบายอากาศ รวมทั้งที่จับเครื่องมือให้ สะอาดอยู่เสมอ

เมื่อจำเป็นต้องเปลี่ยนสายไฟฟ้า ให้ส่งเครื่องให้บริษัท บ็อชหรือศูนย์บริการลูกค้าสำหรับเครื่องมือไฟฟ้า บ็อช ที่ได้รับ มอบหมายทำการเปลี่ยนให้ เพื่อหลีกเลี่ยงอันตรายด้าน ความปลอดภัย

ทำความสะอาดที่จับไม้เลื่อยเป็นประจำ สำหรับการทำความสะอาด ให้ถอดไม้เลื่อยออกจากตัวเครื่อง และจับเครื่องเคาะ บนพื้นราบเบาๆ

ตรวจสอบหัวจับไม้เลื่อย เป็นประจำ หากสึกหรอ ต้อง ส่งให้ศูนย์บริการหลังการขายของ บ็อช ที่ได้รับมอบหมาย เปลี่ยนใหม่ให้

หล่อลื่นหัวจับไม้เลื่อยเป็นครั้งคราวด้วยน้ำมันหนึ่งหยด (ดูภาพ ประกอบ 13 หน้า 39)

การบริการหลังการขายและ คำแนะนำการใช้งาน

ศูนย์บริการหลังการขายของเรายินดีตอบคำถามเกี่ยวกับการ บำรุงรักษาและการซ่อมแซมผลิตภัณฑ์ของท่าน รวมทั้ง ชิ้นส่วนอะไหล่ ภาพแยกชิ้นประกอบและข้อมูลเกี่ยวกับ ชิ้นส่วนอะไหล่ยังสามารถดูได้ใน:

www.bosch-pt.com

ทีมงานให้คำแนะนำการใช้งานของ บ็อช ยินดีตอบคำถาม เกี่ยวกับผลิตภัณฑ์ของเราและอุปกรณ์ประกอบของผลิตภัณฑ์ เมื่อต้องการสอบถามและสั่งซื้ออะไหล่ กรุณาแจ้ง หมายเลขสินค้า 10 หลักบนแผ่นป้ายรุ่นของผลิตภัณฑ์ทุกครั้ง

ไทย

บริษัท โรเบิร์ต บ็อช จำกัด
ชั้น 11 ตึกลิเบอร์ตี สแควร์
287 ถนนสีลม บางรัก
กรุงเทพฯ 10500

โทรศัพท์ 02 6393111

โทรสาร 02 2384783

บริษัท โรเบิร์ต บ็อช จำกัด ตู้ ปณ. 2054

กรุงเทพฯ 10501 ประเทศไทย

www.bosch.co.th

ศูนย์บริการซ่อมและฝึกอบรม บ็อช

อาคาร ลาซาลทาวเวอร์ ชั้น G ห้องเลขที่ 2

บ้านเลขที่ 10/11 หมู่ 16

ถนนศรีนครินทร์

ตำบลบางแก้ว อำเภอบางพลี

จังหวัดสมุทรปราการ 10540

ประเทศไทย

โทรศัพท์ 02 7587555

โทรสาร 02 7587525

การกำจัดขยะ

เครื่องมือ อุปกรณ์ประกอบ และหีบห่อ ต้องนำไปแยกประเภท วัสดุเพื่อนำกลับมาใช้ใหม่โดยไม่ทำลายสภาพแวดล้อม

อย่าทิ้งเครื่องมือไฟฟ้าลงในขยะบ้าน!



ขอสงวนสิทธิ์ในการเปลี่ยนแปลงโดยไม่ต้องแจ้งล่วงหน้า

Bahasa Indonesia

Petunjuk-Petunjuk Umum untuk Perakas Listrik

⚠ PERHATIKANLAH Bacalah semua petunjuk-petunjuk untuk keselamatan kerja dan petunjuk-petunjuk untuk penggunaan.

Kesalahan dalam menjalankan petunjuk-petunjuk untuk keselamatan kerja dan petunjuk-petunjuk untuk penggunaan dapat mengakibatkan kontak listrik, kebakaran dan/atau luka-luka yang berat.

Simpanlah semua petunjuk-petunjuk untuk keselamatan kerja dan petunjuk-petunjuk lainnya untuk penggunaan di masa depan.

Kata „perkakas listrik“ yang disebutkan di dalam petunjuk-petunjuk untuk keselamatan kerja adalah sebutan untuk perkakas listrik pakai listrik jaringan (dengan kabel) dan untuk perkakas listrik tenaga baterai (tanpa kabel listrik).

Keselamatan kerja di tempat kerja

- ▶ **Jagalah supaya tempat kerja selalu bersih dan terang.** Tempat kerja yang tidak rapi atau tidak terang dapat mengakibatkan terjadinya kecelakaan.
- ▶ **Janganlah menggunakan perkakas listrik di tempat di mana dapat terjadi ledakan, di mana ada cairan, gas atau debu yang mudah terbakar.** Perakkas listrik dapat memancarkan bunga api yang lalu mengakibatkan debu atau uap terbakar.
- ▶ **Selama menggunakan perkakas listrik, jauhkan anak-anak dan orang-orang lain dari tempat kerja.** Jika konsentrasi terganggu, bisa jadi Anda tidak bisa mengendalikan perkakas listrik tersebut.

Keamanan listrik

- ▶ **Steker dari perkakas listrik harus cocok pada stopkontak. Janganlah sekali-kali merubah steker. Janganlah menggunakan steker perantara bersama dengan perkakas listrik yang mempunyai hubungan arde.** Steker yang tidak dirubah dan stopkontak yang cocok mengurangi bahaya terjadinya kontak listrik.
- ▶ **Jagalah supaya badan Anda tidak bersentuhan dengan permukaan yang mempunyai hubungan arde, misalnya pipa-pipa, radiator pemanas ruangan, kompor listrik dan lemari es.** Ada risiko besar terjadi kontak listrik, jika badan Anda mempunyai hubungan arde.
- ▶ **Jagalah supaya perkakas listrik tidak kena hujan atau menjadi basah.** Air yang masuk ke dalam perkakas listrik menambah risiko terjadinya kontak listrik.
- ▶ **Janganlah menyalah gunakan kabel listrik untuk mengangkat dan menggantungkan perkakas listrik atau untuk menarik steker dari stopkontak. Jagalah supaya kabel listrik tidak kena panas, minyak, pinggiran yang tajam atau bagian-bagian perakas yang bergerak.** Kabel listrik yang rusak atau tersangkut menambah risiko terjadinya kontak listrik.

- ▶ **Jika Anda menggunakan perkakas listrik di luar gedung, gunakanlah hanya kabel sambungan yang juga cocok untuk pemakaian di luar gedung.** Penggunaan kabel sambungan yang cocok untuk pemakaian di luar gedung mengurangi risiko terjadinya kontak listrik.
- ▶ **Jika penggunaan perkakas listrik di tempat yang basah tidak bisa dihindarkan, gunakanlah sakelar pengaman terhadap arus penyimpangan.** Penggunaan sakelar pengaman terhadap arus penyimpangan mengurangi risiko terjadinya kontak listrik.

Keselamatan kerja

- ▶ **Berhati-hatilah selalu, perhatikanlah apa yang Anda kerjakan dan bekerjalah dengan seksama jika menggunakan perkakas listrik. Janganlah menggunakan perkakas listrik, jika Anda capai atau berada di bawah pengaruh narkoba, minuman keras atau obat.** Jika Anda sekejap mata saja tidak berhati-hati sewaktu menggunakan perkakas listrik, dapat terjadi luka-luka berat.
- ▶ **Pakailah pakaian dan sarana pelindung dan pakailah selalu kaca mata pelindung.** Dengan memakai pakaian dan sarana pelindung, misalnya kedok anti debu (masker), sepatu tertutup yang tidak licin, helm pelindung atau pemalut telinga sesuai dengan pekerjaan yang dilakukan dengan perkakas listrik, bahaya terjadinya luka-luka dapat dikurangi.
- ▶ **Jagalah supaya perkakas listrik tidak dihidupkan secara tidak disengaja. Perhatikan bahwa perkakas listrik dalam penyetelan mati, jika steker disambungkan pada pengadaan listrik dan/atau baterai, jika perkakas listrik diangkat atau dibawa.** Jika selama mengangkat perkakas listrik jari Anda berada pada tombol untuk menghidupkan dan mematikan atau perkakas listrik yang dalam penyetelan hidup disambungkan pada listrik, dapat terjadi kecelakaan.
- ▶ **Lepaskan semua perkakas-perkakas penyetelan atau kunci-kunci pas sebelum perkakas listrik dihidupkan.** Perakkas atau kunci yang berada di dalam bagian yang berputar dapat mengakibatkan terjadinya luka-luka.
- ▶ **Aturkan badan sedemikian sehingga Anda bisa bekerja dengan aman. Berdirilah secara mantap dan jagalah selalu keseimbangan.** Dengan demikian Anda bisa mengendalikan perkakas listrik dengan lebih baik, jika terjadi sesuatu dengan tiba-tiba.
- ▶ **Pakailah pakaian yang cocok. Janganlah memakai pakaian yang longgar atau perhiasan. Jagalah supaya rambut, pakaian dan sarung tangan tidak masuk dalam bagian-bagian perakas yang bergerak.** Pakaian yang longgar, rambut panjang atau perhiasan dapat tersangkut dalam bagian perakas yang bergerak.
- ▶ **Jika ada kemungkinan untuk memasangkan sarana penghisapan dan penampungan debu, perhatikan bahwa sarana-sarana ini telah dipasangkan dan digunakan dengan betul.** Penggunaan sarana penghisapan bisa mengurangi bahaya yang disebabkan debu.

Penggunaan dan penanganan perkakas listrik dengan seksama

- ▶ **Janganlah membebankan perkakas listrik terlalu berat. Gunakan selalu perkakas listrik yang cocok untuk pekerjaan yang dilakukan.** Dengan perkakas listrik yang cocok Anda bekerja lebih baik dan lebih aman dalam batas-batas kemampuan yang ditentukan.
- ▶ **Janganlah menggunakan perkakas listrik yang tombolnya rusak.** Perkakas listrik yang tidak bisa dihidupkan atau dimatikan, berbahaya dan harus direparasikan.
- ▶ **Tariklah steker dari stopkontak dan/atau keluarkan baterai, sebelum Anda melakukan penyetelan pada perkakas listrik, mengganti alat-alat kerja atau sebelum menyimpan perkakas listrik.** Tindakan keselamatan kerja ini mengurangi bahaya perkakas listrik hidup secara tidak disengaja.
- ▶ **Simpanlah perkakas listrik yang tidak digunakan di luar jangkauan anak-anak. Janganlah mengizinkan orang-orang yang tidak mengenal perkakas listrik ini atau yang belum membaca petunjuk-petunjuk ini, menggunakan perkakas listrik ini.** Perkakas listrik bisa menjadi berbahaya, jika digunakan oleh orang-orang yang tidak mengenalnya.
- ▶ **Rawatlah perkakas listrik dengan seksama. Periksalah, apakah bagian-bagian perkakas listrik yang bergerak berfungsi dengan baik dan tidak tersangkut, apakah ada bagian-bagian yang patah atau rusak sedemikian, sehingga dapat mempengaruhi jalannya perkakas listrik. Biarkan bagian-bagian perkakas yang rusak direparasikan, sebelum Anda mulai menggunakan perkakas listrik.** Banyak kecelakaan terjadi karena perkakas listrik tidak dirawat dengan seksama.
- ▶ **Perhatikan supaya alat-alat pemotong selalu tajam dan bersih.** Alat-alat pemotong dengan mata-mata pemotong yang tajam dan dirawat dengan seksama tidak mudah tersangkut dan lebih mudah dikendalikan.
- ▶ **Gunakanlah semua perkakas listrik, aksesoris, alat-alat kerja dsb. sesuai dengan petunjuk-petunjuk. Perhatikan syarat-syarat kerja dan macam pekerjaan yang dilakukan.** Penggunaan perkakas listrik untuk macam pekerjaan yang tidak cocok dengan kegunaannya bisa mengakibatkan keadaan yang berbahaya.

Servis

- ▶ **Biarkan perkakas listrik Anda direparasikan hanya oleh orang-orang ahli yang berpengalaman dan hanya dengan menggunakan suku cadang yang asli.** Dengan demikian terjamin keselamatan kerja dengan perkakas listrik ini secara berkesinambungan.

Petunjuk-petunjuk untuk keselamatan kerja untuk mesin jigsaw

- ▶ **Peganglah perkakas listrik hanya pada pegangan yang terisolir jika Anda melakukan pekerjaan yang memungkinkan alat pemotong ini menjalin kontak dengan kabel listrik yang tidak terlihat atau kabelnya sendiri.**

Alat kerja yang bersentuhan dengan kabel yang bertebaran dapat mengakibatkan bagian-bagian logam dari perkakas listrik juga ikut dialiri tegangan arus dan mengakibatkan terjadinya kontak listrik.

Petunjuk-petunjuk lainnya untuk keselamatan kerja dan untuk penggunaan

- ▶ **Jauhkan tangan-tangan Anda dari tempat penggergajian. Janganlah menjangkau di bawah benda yang dikerjakan.** Persentuhan dengan mata gergaji bisa mengakibatkan luka-luka.
- ▶ **Hidupkan dahulu perkakas listrik, baru kemudian perkakas listrik didekatkan pada benda yang dikerjakan.** Jika tidak demikian ada bahaya perkakas listrik membanting jika alat kerja tersangkut dalam benda yang dikerjakan.
- ▶ **Selama menggergaji, perhatikanlah supaya seluruh permukaan pelat dasar berada pada benda yang dikerjakan.** Mata gergaji yang tersangkut bisa patah atau mengakibatkan terjadinya bantingan.
- ▶ **Setelah pekerjaan menggergaji rampung, matikan perkakas listrik dan tunggulah sampai mata gergaji berhenti bergerak, baru setelah itu mata gergaji dikeluarkan dari jalur pemotongan.** Dengan demikian bisa dihindarkan terjadinya bantingan dan perkakas listrik bisa diletakkan dengan aman.
- ▶ **Gunakanlah hanya mata gergaji-mata gergaji yang tidak rusak dan mulus.** Mata gergaji-mata gergaji yang melengkung atau tidak tajam bisa patah, membuat potongan tidak bagus atau mengakibatkan bantingan.
- ▶ **Setelah perkakas listrik dimatikan, janganlah meremkan mata gergaji dengan cara menekan pada sisinya.** Ini bisa mengakibatkan mata gergaji menjadi rusak, patah atau bisa mengakibatkan bantingan.
- ▶ **Gunakanlah alat detektor logam yang cocok untuk mencari kabel dan pipa yang tidak terlihat atau hubungi perusahaan pengadaan setempat.** Sentuhan dengan kabel-kabel listrik dapat mengakibatkan api dan kontak listrik. Pipa gas yang dirusak dapat mengakibatkan ledakan. Pipa air yang dirusak mengakibatkan kerusakan barang-barang atau dapat mengakibatkan kontak listrik.
- ▶ **Usahakan supaya benda yang dikerjakan tidak goyang.** Benda yang ditahan dalam alat pemegang atau bais lebih mantap daripada benda yang dipegang dengan tangan.
- ▶ **Sebelum meletakkan perkakas listrik, tunggulah sampai perkakas berhenti memutar.** Alat kerja bisa tersangkut dan membuat perkakas listrik tidak bisa dikendalikan.
- ▶ **Sebelum mulai dengan pekerjaan pada perkakas listrik, tariklah steker dari stopkontak.**
- ▶ **Mata gergaji sebaiknya tidak lebih panjang daripada yang diperlukan untuk pemotongan yang hendak dikerjakan.** Untuk menggergaji belokan-belokan patah, gunakanlah mata gergaji yang tidak lebar.







26 | Bahasa Indonesia

- ▶ **Periksalah apakah kedudukan mata gergaji sudah kencang.** Mata gergaji yang tidak kencang duduknya bisa meleset ke luar dan lalu melukai Anda.
- ▶ **Pada waktu melepaskan mata gergaji, peganglah perkakas listrik sedemikian sehingga orang atau binatang tidak terluka oleh mata gergaji yang terlompat ke luar.**
- ▶ **Debu dari berbagai bahan misalnya cat yang mengandung timbel, beberapa jenis kayu, bahan mineral dan logam bisa berbahaya bagi kesehatan dan mengakibatkan reaksi alergi, penyakit saluran pernafasan dan/ atau kanker.** Bahan-bahan yang mengandung asbestos hanya boleh dikerjakan oleh orang-orang ahli yang berpengalaman.
 - Perhatikanlah supaya ada pertukaran udara di tempat kerja.
 - Kami anjurkan supaya Anda memakai kedok anti debu dengan saringan (filter) kelas P2.
 Taatilah peraturan-peraturan untuk bahan-bahan yang dikerjakan yang berlaku di negara Anda.
- ▶ **Hindarkan debu yang banyak terkumpul di tempat kerja.** Debu dapat menyulut dengan mudahnya.
- ▶ **Perhatikan tegangan jaringan listrik! Tegangan jaringan listrik harus sesuai dengan tegangan listrik yang tercantum pada label tipe perkakas listrik.**
- ▶ **Bohel pelindung (lihat gambar 12, halaman 39) yang berada pada rumahan menghindarkan terjadinya sentuhan yang tidak disengaja pada mata gergaji selama penggunaan perkakas listrik, dan oleh karena itu tidak boleh dilepaskan.**
- ▶ **Sebelum menggergaji bahan kayu, pelat serbuk kayu, bahan bangunan dsb., periksalah apakah ada benda-benda seperti misalnya paku, sekrup atau benda sejenis, dan jika ada, singkirkannya.**
- ▶ **Hanya bahan-bahan yang lunak seperti kayu, pelat gips berlapis karton dsb. yang boleh digergaji dengan cara pemotongan dalam.**
- ▶ **Alat untuk menghindarkan permukaan benda yang dipotong terkupas berguna sewaktu memotong kayu.**
- ▶ **Cocokkan penyetelan pada perkakas listrik Anda dengan pekerjaan yang akan dilakukan dengannya. Misalnya jika mengerjakan logam atau melakukan pemotongan yang berliku-liku, kurangi jumlah langkah dan keayunan.**
- ▶ **Gunakanlah selalu alat penghisap pada penggunaan tertentu jika memungkinkan. Tiuplah dengan rutin kisi-kisi ventilasi dan nyalakan sisa pemutus arus (PRCD).** Saat pengerjaan bahan logam, debu konduktif dapat disimpan di dalam perkakas listrik. Isolasi keselamatan dari perkakas listrik dapat terganggu.

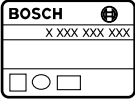
Simbol-Simbol

Simbol-simbol berikut penting pada waktu membaca dan untuk mengerti petunjuk-petunjuk untuk penggunaan. Lihat dan ingati simbol-simbol dan artinya. Penafsiran yang betul dari simbol-simbol sangat membantu Anda untuk menggunakan perkakas listrik dengan jitu dan sesuai dengan petunjuk untuk keselamatan kerja.

Simbol	Arti
	GST 25 M: Mesin jigsaw dengan Constant Electronic dan pegangan Bidang berwarna abu-abu: gagang (permukaan yang dipegang dengan isolasi)
	Bacalah semua petunjuk-petunjuk untuk keselamatan kerja dan petunjuk-petunjuk untuk penggunaan
	Sebelum melakukan semua pekerjaan pada perkakas listrik, tarikkan steker dari stopkontak
	Pakailah sarung tangan pelindung
	Informasi tambahan
	Arah gerakan
	Arah reaksi
	Kegiatan berikut
	Alat peniup serbuk
	Jumlah langkah rendah
	Jumlah langkah tinggi
	Menghidupkan perkakas listrik
	Mematikan perkakas listrik
	Mengunci tombol untuk menghidupkan dan mematikan
	Kegiatan yang dilarang
	Hasil yang betul
	Pada waktu menggergaji logam, oleskan bahan pendingin atau bahan pelumas di garis pemotongan

Simbol	Arti
	Nomor model (10 angka)
P ₁	Masukan nominal
n ₀	Jumlah langkah tanpa beban
	Kedalaman pemotongan maks.
	Kayu
	Aluminium
	Logam
	Berat sesuai dengan EPTA-Procedure 01:2014
	Simbol dari klasifikasi keamanan II (isolasi perlindungan yang lengkap)

Pasokan standar

Mesin jigsaw.

Alat untuk menghindarkan permukaan benda yang dipotong terkupas, mistar kesejajaran, alat kerja dan aksesoris lain yang terlihat pada gambar atau yang dijelaskan, tidak termasuk dalam mesin standar yang dipasok.

Semua aksesoris yang tersedia dapat Anda lihat di dalam program aksesoris.

Penggunaan alat

Perkakas listrik ini cocok untuk pemotongan dan pemotongan dalam dengan ketentuan harus diletakkan secara langsung di atas permukaan benda yang akan dikerjakan dari kayu, bahan sintetik, logam, pelat keramik dan karet. Perkakas listrik ini bagus untuk pemotongan lurus dan berliku-liku. Perhatikanlah selalu petunjuk-petunjuk untuk penggunaan mata gergaji.

Data teknis

Data-data teknis dari produk ini tertera di dalam tabel pada halaman 33 dari petunjuk-petunjuk untuk penggunaan ini.

Data-data berlaku untuk tegangan nominal [U] 230 V. Pada tegangan yang lebih rendah dan pada model khusus mancanegara data-data ini bisa berlainan.

Memasang dan menggunakan

Kegiatan	Gambar	Halaman
Memasang mata gergaji	1	34
Melepaskan mata gergaji	2	34
Menghidupkan alat peniup serbuk	3	35
Memasang alat untuk menghindarkan permukaan benda yang dipotong terkupas	4	35

Kegiatan	Gambar	Halaman
Menyetel keayunan	5	35
Melakukan penyetelan pendahuluan jumlah langkah	6	36
Menghidupkan/mematikan	7	36
Mengoles bahan pelumas pada waktu mengerjakan logam	8	37
Pemotongan dalam	9	37
Memasang kap penutup	10	37
Memasang dan menggunakan mistar kesejajaran	11	38
Memilih aksesoris	-	40-41

Rawatan dan kebersihan

► **Jagalah supaya perkakas listrik, lubang ventilasi serta pemegang alat kerja selalu bersih, supaya hasil kerja bagus dan penggunaan perkakas listrik aman.**

Jika kabel listrik harus digantikan, pekerjaan ini harus dilakukan oleh Bosch atau Service Center untuk perkakas listrik Bosch yang resmi, supaya keselamatan kerja selalu terjamin.

Bersihkanlah pemegang mata gergaji secara berkala. Untuk melakukannya, keluarkan mata gergaji dari perkakas listrik dan ketok-ketokkan perkakas listrik dengan hati-hati pada permukaan yang datar.

Periksalah rol pengendalian secara berkala. Jika rol pengendalian aus, harus digantikan oleh Service Center Bosch yang resmi.

Sebaiknya rol pengendalian kadang-kadang dilumasi dengan setetes minyak (lihat gambar 13, halaman 39).

Layanan pasca beli dan konseling terkait pengoperasian

Layanan pasca beli Bosch menjawab semua pertanyaan Anda terkait reparasi dan maintenance serta suku cadang produk ini. Gambar tiga dimensi dan informasi terkait suku cadang dapat Anda lihat di:

www.bosch-pt.com

Tim konseling pengoperasian dari Bosch dengan senang hati membantu Anda, jika Anda hendak bertanya tentang produk-produk kami dan aksesorisnya.

Jika Anda hendak menanyakan sesuatu atau memesan suku cadang, sebutkan selalu nomor model yang terdiri dari 10 angka dan tercantum pada label tipe produk.

Indonesia

PT Robert Bosch
Palma Tower 10th Floor
Jl. RA Kartini II-S Kaveling 6 Sek II
Pondok Pinang, Kebayoran Lama
Jakarta Selatan 12310
Tel.: (021) 3005 5800
Fax: (021) 3005 5801
E-Mail: boschpowertools@id.bosch.com
www.bosch-pt.co.id

28 | Tiếng Việt

Cara membuang

Perkakas listrik, aksesoris dan kemasan sebaiknya didaur ulangkan sesuai dengan upaya untuk melindungi lingkungan hidup.



Janganlah membuang perkakas listrik dalam sampah rumah tangga!

Perubahan dapat terjadi tanpa pemberitahuan sebelumnya.

Tiếng Việt**Cảnh báo tổng quát cách sử dụng an toàn dụng cụ điện cầm tay**

⚠ CẢNH BÁO Đọc kỹ mọi cảnh báo an toàn và hướng dẫn. Không tuân thủ mọi cảnh báo và hướng dẫn được liệt kê dưới đây có thể bị điện giật, gây cháy và/hoặc bị thương tật nghiêm trọng.

Hãy giữ tất cả tài liệu về cảnh báo và hướng dẫn để tham khảo về sau.

Thuật ngữ “dụng cụ điện cầm tay” trong phần cảnh báo là để cập đến sự sử dụng dụng cụ điện cầm tay của bạn, loại sử dụng điện nguồn (có dây cắm điện) hay vận hành bằng pin (không dây cắm điện).

Khu vực làm việc an toàn

- ▶ **Giữ nơi làm việc sạch và đủ ánh sáng.** Nơi làm việc bừa bộn và tối tăm dễ gây ra tai nạn.
- ▶ **Không vận hành dụng cụ điện cầm tay trong môi trường dễ gây nổ, chẳng hạn như nơi có chất lỏng dễ cháy, khí đốt hay rác.** Dụng cụ điện cầm tay tạo ra các tia lửa nên có thể làm rác bén cháy hay bốc khói.
- ▶ **Không để trẻ em hay người đến xem đứng gần khi vận hành dụng cụ điện cầm tay.** Sự phân tâm có thể gây ra sự mất điều khiển.

An toàn về điện

- ▶ **Phích cắm của dụng cụ điện cầm tay phải thích hợp với ổ cắm.** Không bao giờ được cải biến lại phích cắm dưới mọi hình thức. Không được sử dụng phích tiếp hợp nối tiếp đất (dây mát). Phích cắm nguyên bản và ổ cắm đúng loại sẽ làm giảm nguy cơ bị điện giật.
- ▶ **Tránh không để thân thể tiếp xúc với đất hay các vật có bề mặt tiếp đất như đường ống, lò sưởi, hàng rào và tủ lạnh.** Có nhiều nguy cơ bị điện giật hơn nếu cơ thể bạn bị tiếp hay nối đất.

- ▶ **Không được để dụng cụ điện cầm tay ngoài mưa hay ở tình trạng ẩm ướt.** Nước vào máy sẽ làm tăng nguy cơ bị điện giật.
- ▶ **Không được lạm dụng dây dẫn điện.** Không bao giờ được nắm dây dẫn để xách, kéo hay rút phích cắm dụng cụ điện cầm tay. Không để dây gần nơi có nhiệt độ cao, dầu nhớt, vật nhọn bén hay bộ phận chuyển động. Làm hỏng hay cuộn rối dây dẫn làm tăng nguy cơ bị điện giật.
- ▶ **Khi sử dụng dụng cụ điện cầm tay ngoài trời, dùng dây nối thích hợp cho việc sử dụng ngoài trời.** Sử dụng dây nối thích hợp cho việc sử dụng ngoài trời làm giảm nguy cơ bị điện giật.
- ▶ **Nếu việc sử dụng dụng cụ điện cầm tay ở nơi ẩm ướt là không thể tránh được, dùng thiết bị ngắt mạch tự động (RCD) bảo vệ nguồn.** Sử dụng thiết bị ngắt mạch tự động RCD làm giảm nguy cơ bị điện giật.

An toàn cá nhân

- ▶ **Hãy tỉnh táo, biết rõ mình đang làm gì và hãy sử dụng ý thức khi vận hành dụng cụ điện cầm tay.** Không sử dụng dụng cụ điện cầm tay khi đang mệt mỏi hay đang bị tác động do chất gây nghiện, rượu hay dược phẩm gây ra. Một thoáng mất tập trung khi đang vận hành dụng cụ điện cầm tay có thể gây thương tích nghiêm trọng cho bản thân.
- ▶ **Sử dụng trang bị bảo hộ cá nhân.** Luôn luôn đeo kính bảo vệ mắt. Trang bị bảo hộ như khẩu trang, giày chống trượt, nón bảo hộ, hay dụng cụ bảo vệ tai khi được sử dụng đúng nơi đúng chỗ sẽ làm giảm nguy cơ thương tật cho bản thân.
- ▶ **Phòng tránh máy khởi động bất ngờ.** Bảo đảm công tắc máy ở vị trí tắt trước khi cắm vào nguồn điện và/hay lắp pin vào, khi nhắc máy lên hay khi mang xách máy. Ngáng ngón tay vào công tắc máy để xách hay kích hoạt dụng cụ điện cầm tay khi công tắc ở vị trí mở dễ dẫn đến tai nạn.
- ▶ **Lấy mọi chìa hay khóa điều chỉnh ra trước khi mở điện dụng cụ điện cầm tay.** Khóa hay chìa còn gắn dính vào bộ phận quay của dụng cụ điện cầm tay có thể gây thương tích cho bản thân.
- ▶ **Không rướn người.** Luôn luôn giữ tư thế đứng thích hợp và thẳng bằng. Điều này tạo cho việc điều khiển dụng cụ điện cầm tay tốt hơn trong mọi tình huống bất ngờ.
- ▶ **Trang phục thích hợp.** Không mặc quần áo rộng lủng thụng hay mang trang sức. Giữ tóc, quần áo và găng tay xa khỏi các bộ phận chuyển động. Quần áo rộng lủng thụng, đồ trang sức hay tóc dài có thể bị cuốn vào các bộ phận chuyển động.

► **Nếu có các thiết bị đi kèm để nối máy hút bụi và các phụ kiện khác, bảo đảm các thiết bị này được nối và sử dụng tốt.** Việc sử dụng các thiết bị gom hút bụi có thể làm giảm các độc hại liên quan đến bụi gây ra.

Sử dụng và bảo dưỡng dụng cụ điện cầm tay

- **Không được ép máy. Sử dụng dụng cụ điện cầm tay đúng loại theo đúng ứng dụng của bạn.** Dụng cụ điện cầm tay đúng chức năng sẽ làm việc tốt và an toàn hơn theo đúng tiến độ mà máy được thiết kế.
- **Không sử dụng dụng cụ điện cầm tay nếu như công tắc không tắt và mở được.** Bất kỳ dụng cụ điện cầm tay nào mà không thể điều khiển được bằng công tắc là nguy hiểm và phải được sửa chữa.
- **Rút phích cắm ra khỏi nguồn điện và/hay pin ra khỏi dụng cụ điện cầm tay trước khi tiến hành bất kỳ điều chỉnh nào, thay phụ kiện, hay cắt dụng cụ điện cầm tay.** Các biện pháp ngăn ngừa như vậy làm giảm nguy cơ dụng cụ điện cầm tay khởi động bất ngờ.
- **Cắt giữ dụng cụ điện cầm tay không dùng tới nơi trẻ em không lấy được và không cho người chưa từng biết dụng cụ điện cầm tay hay các hướng dẫn này sử dụng dụng cụ điện cầm tay.** Dụng cụ điện cầm tay nguy hiểm khi ở trong tay người chưa được chỉ cách sử dụng.
- **Bảo quản dụng cụ điện cầm tay.** Kiểm tra xem các bộ phận chuyển động có bị sai lệch hay kẹt, các bộ phận bị rạn nứt và các tình trạng khác có thể ảnh hưởng đến sự vận hành của máy. Nếu bị hư hỏng, phải sửa chữa máy trước khi sử dụng. Nhiều tai nạn xảy ra do bảo quản dụng cụ điện cầm tay tồi.
- **Giữ các dụng cụ cắt bén và sạch.** Bảo quản đúng cách các dụng cụ cắt có cạnh cắt bén làm giảm khả năng bị kẹt và dễ điều khiển hơn.
- **Sử dụng dụng cụ điện cầm tay, phụ kiện, đầu cài v.v., đúng theo các chỉ dẫn này, hãy lưu ý đến điều kiện làm việc và công việc phải thực hiện.** Sử dụng dụng cụ điện cầm tay khác với mục đích thiết kế có thể tạo nên tình huống nguy hiểm.

Bảo dưỡng

- **Đưa dụng cụ điện cầm tay của bạn đến thợ chuyên môn để bảo dưỡng, chỉ sử dụng phụ tùng đúng chủng loại để thay.** Điều này sẽ đảm bảo sự an toàn của máy được giữ nguyên.

Các cảnh Báo An Toàn cho loại Máy Cưa Xọc

► **Nắm giữ dụng cụ điện nơi phần nắm cách điện khi thực hiện việc gia công nơi dụng cụ cắt có thể chạm vào dây điện không nhìn thấy được hay chính dây của máy.** Dụng cụ cắt chạm phải dây có điện có thể làm cho các bộ phận kim loại không được bao bọc có điện và giết người vận hành máy.

Các Hướng Dẫn An Toàn và Vận Hành Bổ Sung

- **Đề tay tránh xa khỏi phạm vi cắt. Không được tiếp xúc với phần bên dưới vật gia công.** Tiếp xúc với lưỡi cưa có thể dẫn đến việc bị thương tích.
- **Chỉ cho máy gia công vật liệu khi máy đã hoạt động.** Nếu không làm vậy thì sẽ có nguy cơ bị giật ngược do dụng cụ cắt bị kẹt chặt trong vật gia công.
- **Hãy lưu ý để đĩa đã nằm an toàn trên vật liệu trong khi cưa.** Lưỡi cưa bị kẹt chặt có thể bị gãy hay gây ra sự giật ngược.
- **Khi đã cắt xong, tắt máy và sau đó rút lưỡi cưa ra khỏi mạch cắt chỉ sau khi lưỡi cưa đã ngừng chuyển động hoàn toàn.** Thực hiện như vậy bạn có thể tránh được sự giật ngược và có thể đặt máy xuống một cách an toàn.
- **Chỉ sử dụng lưỡi cưa còn nguyên vẹn, có tình trạng hoàn hảo.** Lưỡi cưa bị cong hay cùn có thể bị gãy, ảnh hưởng xấu đến sự cắt, và có thể gây ra sự dội ngược.
- **Không được hãm lưỡi cưa cho dừng lại bằng cách tạo lực ép lên hông lưỡi cưa sau khi tắt máy.** Lưỡi cưa có thể bị hỏng, gãy hay gây ra giật ngược.
- **Dùng thiết bị dò tìm thích hợp để xác định nếu có các công trình công cộng lắp đặt ngầm trong khu vực làm việc hay liên hệ với Cty công trình Công cộng địa phương để nhờ hỗ trợ.** Dụng cụ chạm đường dẫn điện có thể gây ra hỏa hoạn và điện giật. Làm hư hại đường dẫn khí ga có thể gây nổ. Làm thủng đường dẫn nước gây hư hỏng tài sản hay có khả năng gây ra điện giật.
- **Kẹp chặt vật gia công.** Vật gia công được kẹp bằng một thiết bị kẹp hay bằng ê-tô thì vững chắc hơn giữ bằng tay.
- **Luôn luôn đợi cho máy hoàn toàn ngừng hẳn trước khi đặt xuống.** Dụng cụ lắp vào máy có thể bị kẹt chặt dẫn đến việc dụng cụ điện cầm tay bị mất điều khiển.









30 | Tiếng Việt

- ▶ **Trước khi tiến hành bất cứ việc gì trên máy, kéo phích cắm điện nguồn ra.**
- ▶ **Lưới cửa không nên dài hơn mức cần thiết đối với dự kiến cắt. Sử dụng lưới cửa bản hẹp khi cửa các đường cong gắt.**
- ▶ **Kiểm tra lưới cửa có được bắt chắc vào.** Lưới cửa gắn vào còn lỏng có thể rơi ra và gây thương tích.
- ▶ **Khi bung lưới cửa, giữ máy ở tư thế sao cho không để người và thú vật có thể bị thương tích do lưới cửa bị bung ra.**
- ▶ **Bụi từ các vật liệu như là lớp phủ có chứa chì, một số loại gỗ, khoáng chất và kim loại có thể gây nguy hại đến sức khỏe và gây dị ứng, dẫn đến sự nhiễm trùng đường hô hấp và/hay gây ung thư.** Vật liệu chứa amiăng có thể chỉ nên để cho các thợ chuyên môn gia công.
 - Tạo không khí thông thoáng nơi làm việc.
 - Khuyến nghị nên mang mặt nạ phòng độc có bộ lọc cấp P2.
 Tuân thủ các qui định của quốc gia bạn liên quan đến loại vật liệu gia công.
- ▶ **Tránh không để rác tích tụ tại nơi làm việc.** Rác có thể dễ dàng bắt lửa.
- ▶ **Tuân thủ theo đúng điện thế! Điện thế nguồn phải đúng với điện thế đã ghi rõ trên nhãn máy.**
- ▶ **Chấn chống tiếp xúc gần ở vỏ máy (xem hình 12, trang 39) ngăn ngừa sự vô tình chạm vào lưới cửa trong quá trình làm việc và có thể không được tháo ra.**
- ▶ **Trước khi cưa gỗ, ván ép, vật liệu xây dựng v.v.. kiểm tra xem có các vật bên ngoài, ví dụ như đinh, vít v.v.. và lấy chúng ra nếu như cần thiết.**
- ▶ **Cửa xọc có thể chỉ nên áp dụng cho loại vật liệu mềm, như là gỗ, thạch cao tấm v.v..**
- ▶ **Miếng chặn chống tưa có thể ngăn cho bề mặt gỗ không bị xơ tước khi cưa.**
- ▶ **Chính đặt dụng cụ điện của bạn cho đúng với loại ứng dụng. Ví dụ, giảm tần suất nhíp chạy và động tác xoay vòng khi cắt kim loại hoặc đường cắt cong gắt.**
- ▶ **Trong điều kiện giới hạn tuyệt đối, luôn luôn sử dụng máy hút bụi trong khả năng có thể. Thổi sạch các khe thông gió thường xuyên và lắp đặt thiết bị ngắt mạch tự động (PRCD). Khi gia công kim loại, các loại mặt bụi dẫn điện có thể lọt vào trong dụng cụ điện. Toàn bộ sự cách điện của dụng cụ điện có thể bị mất tác dụng.**

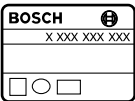
Các Biểu Tượng

Các biểu tượng sau đây mang ý nghĩa quan trọng để suy diễn và hiểu các hướng dẫn sử dụng. Xin vui lòng lưu ý đến các biểu tượng và ý nghĩa của chúng. Sự hiểu đúng các biểu tượng sẽ giúp bạn sử dụng máy một cách tốt và an toàn hơn.

Biểu Tượng	Ý Nghĩa
	GST 25 M: Cửa xọc có bộ phận kiểm soát sự ổn định của dòng điện và tay nắm vòng cung
	Phạm vi có màu xám: Tay nắm (phần nắm được cách điện) Đọc tất cả các cảnh báo an toàn và mọi hướng dẫn
	Trước khi thực hiện bất cứ việc gì trên máy, rút phích cắm ra khỏi ổ điện nguồn
	Hãy mang găng tay bảo vệ
	Các thông tin bổ sung
	Chiều chuyển động
	Chiều phản ứng
	Bước hành động kế tiếp
	Bộ phận thổi mặt cưa
	Tần suất nhíp chạy thấp
	Tần suất nhíp chạy cao
	Mở công tắc
	Để tắt máy
	Công tắc Tắt/Mở được khóa tự-chạy
	Hành động bị cấm

Biểu Tượng	Ý Nghĩa
	Kết quả đúng
	Khi cửa kim loại, bôi chất làm mát/bôi trơn dọc theo đường cắt
	Số mã hàng (10 số)
P_1	Công suất vào danh định
n_0	Tần suất nhịp chạy không tải
	Công suất cắt, tối đa
	Gỗ
	Nhôm
	Kim Loại
	Trọng lượng theo Quy trình EPTA-Procedure 01:2014 (chuẩn EPTA 01:2014)
	Biểu tượng của cấp độ bảo vệ II (hoàn toàn cách điện)

Các món được giao

Cửa xọc.

Miếng chặn chống tưa, dưỡng cạp cạnh song song, dụng cụ ứng dụng và các loại phụ kiện khác được trình bày hay mô tả không phải là một phần tiêu chuẩn được giao kèm.

Bạn có thể tìm thấy thông tin mô tả tổng quát các phụ kiện trong chương trình phụ kiện của chúng tôi.

Dành sử dụng cho

Máy được thiết kế để cắt đứt và cắt loại bỏ gỗ, nhựa mủ, kim loại, gốm sứ và cao su khi các vật liệu này nằm bám chắc trên vật gia công. Máy cũng thích hợp để cắt các đường thẳng và cong. Xin tuân dùng các lưỡi cửa đã được khuyến nghị.

Thông số kỹ thuật

Tính năng kỹ thuật của máy được liệt kê trong Bảng ở trang 33 của các hướng dẫn sử dụng này.

Các giá trị đã cho có hiệu lực cho điện thế danh định [U] 230 V. Đối với điện thế thấp hơn và các loại máy dành riêng cho một số quốc gia, các giá trị này có thể thay đổi.

Lắp và Vận Hành

Loại công việc	Hình ảnh	Trang
Lắp Lưỡi Cửa Vào	1	34
Bung Lưỡi Cửa Ra	2	34
Khởi hoạt thiết bị thổi mát cửa	3	35
Gắn bộ phận chống tưa	4	35
Chỉnh Đặt Động Tác Xoay	5	35
Điều chỉnh sự chọn đặt trước tần suất nhịp chạy	6	36
Mở và Tắt	7	36
Làm trơn khi cắt kim loại	8	37
Cắt Xọc	9	37
Lắp Nắp Đậy Bụi	10	37
Gắn và sử dụng dưỡng cạp cạnh song song	11	38
Chọn phụ tùng	-	40-41

Bảo Dưỡng Và Làm Sạch

► Để an toàn và máy hoạt động đúng chức năng, luôn luôn giữ cho máy và các khe thông hơi cũng như phần lắp dụng cụ được sạch.

Nếu như cần phải thay dây dẫn điện thì công việc này phải do hãng Bosch, hay một đại lý được Bosch ủy nhiệm thực hiện để tránh gặp sự nguy hiểm do mất an toàn.

Làm sạch phần lắp lưỡi cửa thường xuyên. Để thực hiện, lấy lưỡi cửa trong máy ra và gõ nhẹ máy xuống chỗ có bề mặt phẳng.

Kiểm tra bánh lăn định hướng thường xuyên. Nếu bị mòn, phải đưa đến đại lý bảo hành-bảo trì do Bosch ủy nhiệm để thay.

Thỉnh thoảng bôi trơn bánh lăn định hướng bằng một giọt dầu bôi trơn (xem hình 13, trang 39).

Dịch Vụ Sau Khi Bán và Dịch Vụ Ứng Dụng

Bộ phận phục vụ hàng sau khi bán của chúng tôi sẽ trả lời các câu hỏi liên quan đến việc bảo trì và sửa chữa các sản phẩm cũng như các phụ tùng thay thế của bạn. Hình ảnh chi tiết và thông tin phụ tùng thay thế có thể tìm hiểu theo địa chỉ dưới đây:

www.bosch-pt.com

Bộ phận dịch vụ ứng dụng Bosch sẽ hân hạnh trả lời các câu hỏi liên quan đến các sản phẩm của chúng tôi và linh kiện của chúng.

32 | Tiếng Việt

Trong tất cả các phản hồi và đơn đặt phụ tùng, xin vui lòng luôn luôn nhập số hàng hóa 10 chữ số theo nhãn của hàng hóa.

Việt Nam

CN Cty TNHH Bosch Vietnam tại TP. Ho Chi Minh
Tầng 10, Tòa nhà 194 Golden
473 Điện Biên Phủ
Phường 25, Quận Bình Thạnh
Tp. Hồ Chí Minh
Tel.: (08) 6258 3690
Fax: (08) 6258 3692
Hotline: (08) 6250 8555
www.bosch-pt.com.vn

Campuchia

Công ty TNHH Robert Bosch (Campuchia)
Đơn nguyên 8BC, GT Tower, Tầng 08,
Đường 169, Tiệp Khắc Blvd, Sangkat Veal Vong,
Khan 7 Makara, Phnom Penh
VAT TIN : 100 169 511
Tel.: +855 23 900 685
Tel.: +855 23 900 660
www.bosch.com.kh

Thải bỏ

Máy, linh kiện và bao bì phải được phân loại để tái chế theo hướng thân thiện với môi trường.



Không được thải bỏ dụng cụ điện vào chung với rác sinh hoạt!



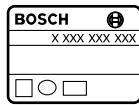

Được quyền thay đổi nội dung mà không phải thông báo trước.

| 33

GST 25 M



3 601 E16 ...

P_1	W	670
n_0	min^{-1}	500 – 2600
	mm	80
	mm	25
	mm	15
	kg	2.9
	/II	●

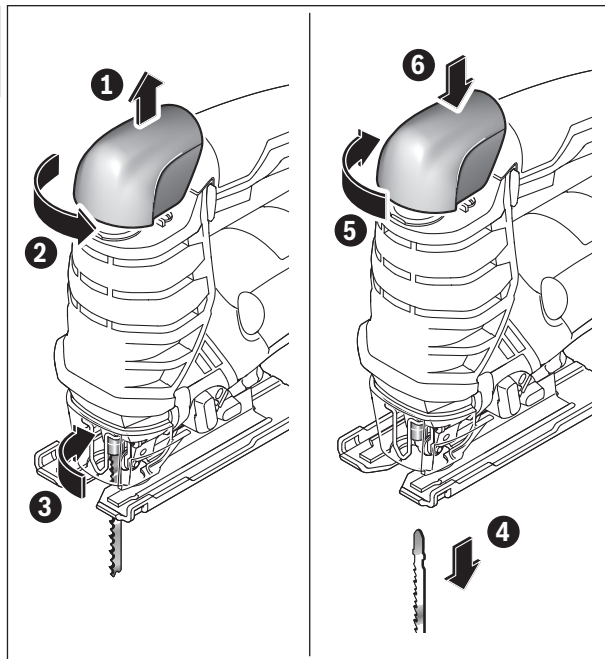
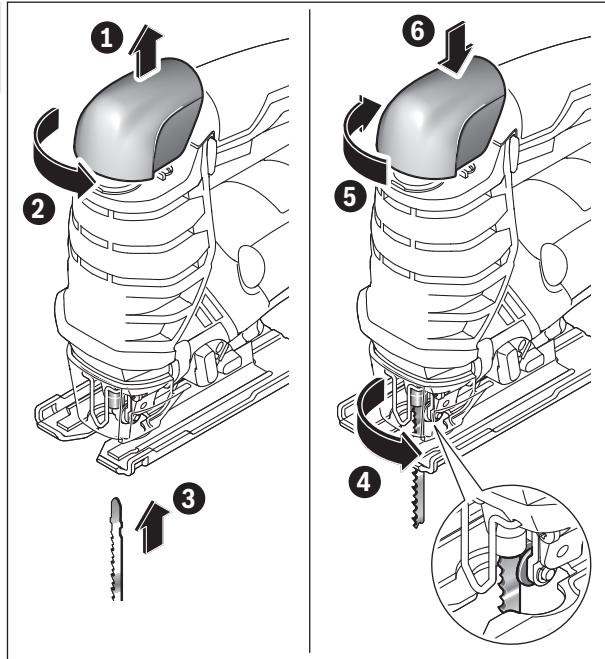

3

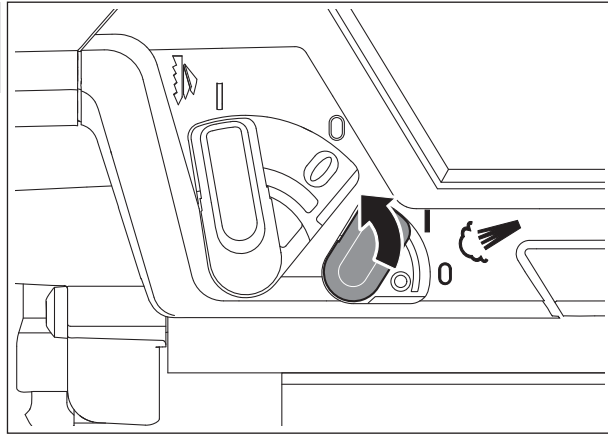
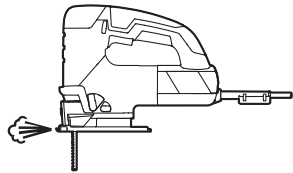

4

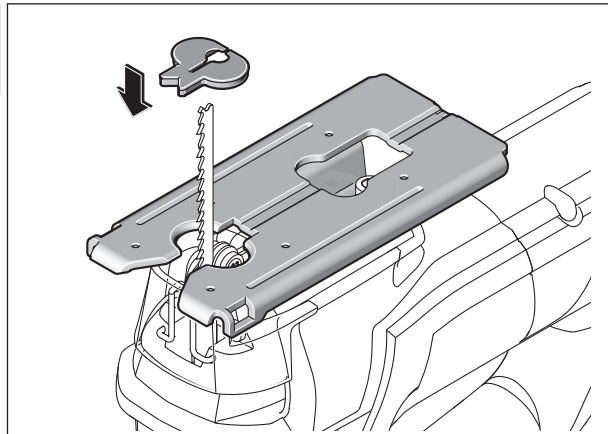
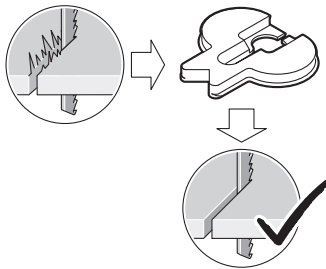

5

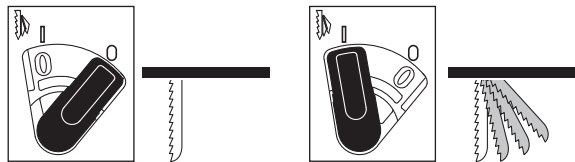
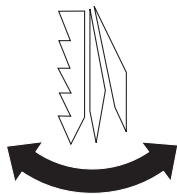

6

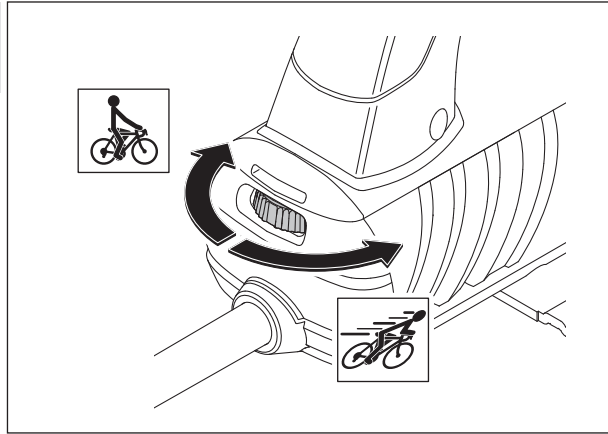

7

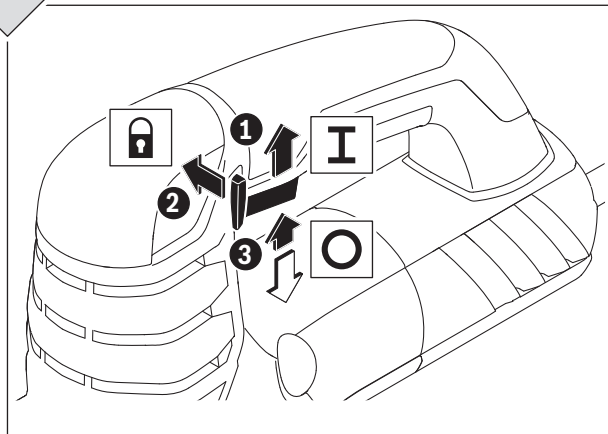
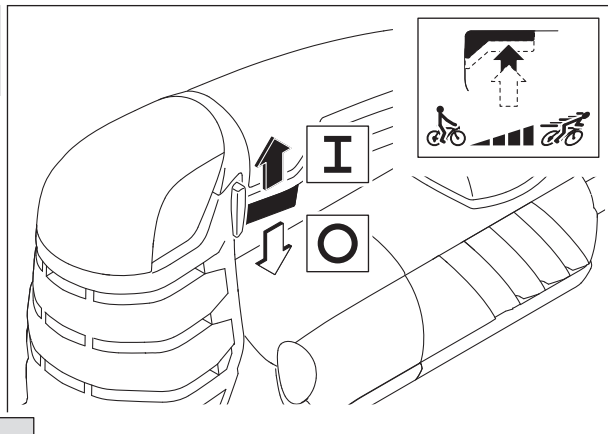

8

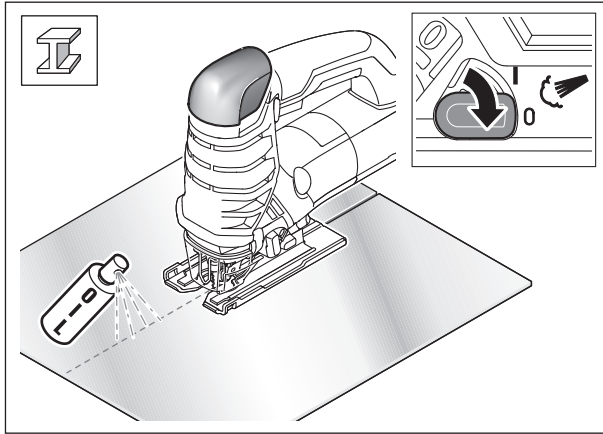

9

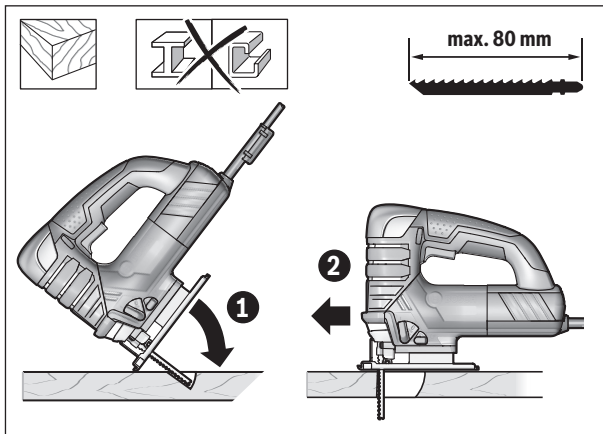

10

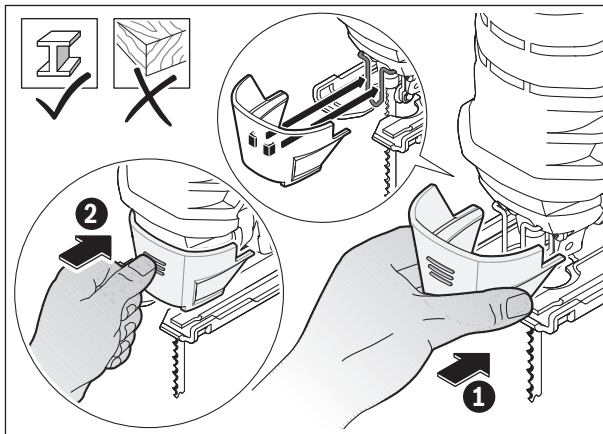
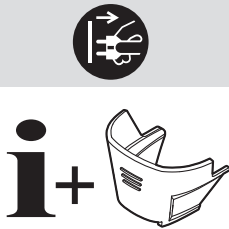

11



i+

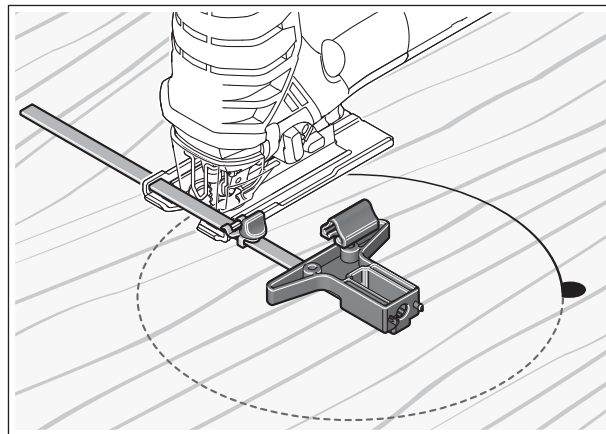
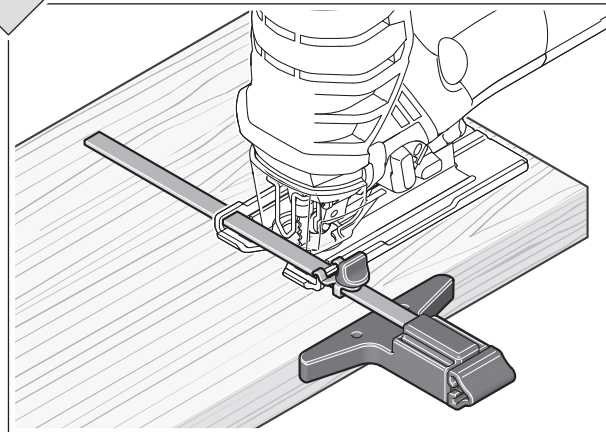
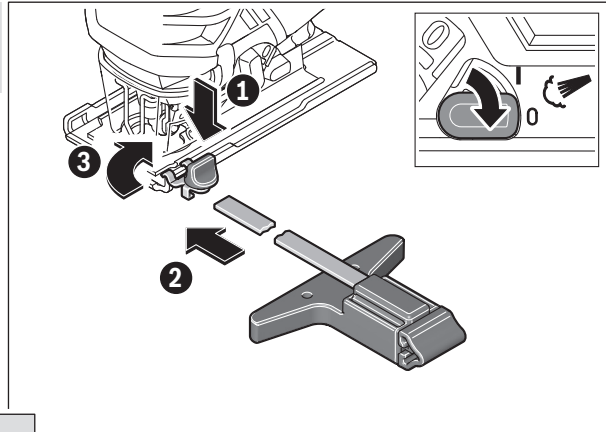
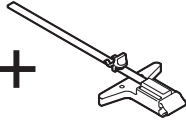

12

i+

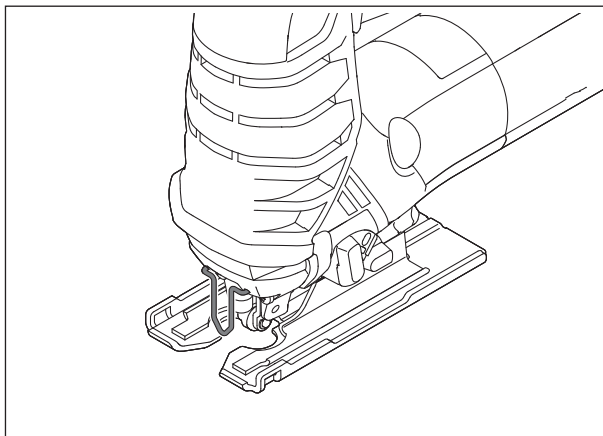

13



i+

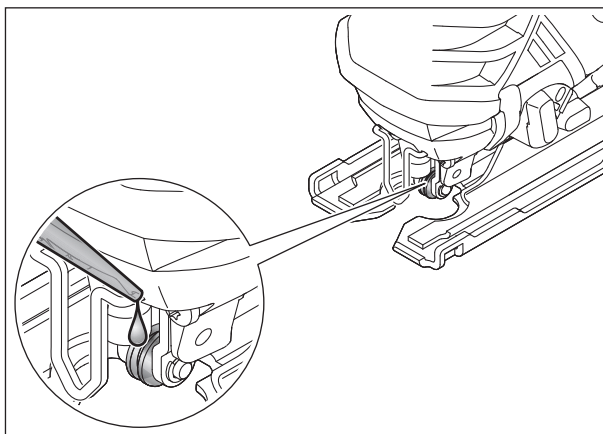



speed for Wood	T 144 D	fast CUT				±5-50mm
speed for Wood	T 244 D	fast CUT				±5-50mm
precision for Wood	T 144 DP					±5-50mm
clean for Wood	T 101 B	clean CUT				± 3-30mm < 30mm
extra-clean for Wood	T 308 B	extra clean CUT				±5-50mm ±5-50mm
extra-clean for HardWood	T 308 BF	extra clean CUT				±5-50mm ±5-50mm ±5-50mm Multiplex
special for Laminate	T 101 BIF	clean CUT				±1,5-15mm
basic for Metal	T 118 B					±2,5-6mm
PROGRESSOR for Metal	T 123 X	fast CUT				ALU ±1,5-10mm < 30mm < 30mm
special for Alu	T 127 D	fast CUT				ALU < 30mm epoxy < 30mm ± 3-15mm
PROGRESSOR for Wood & Metal	T 345 XF	fast CUT				< 65mm < 65mm < 65mm
speed for Metal	T 121 AF	fast CUT	long life			± 1-3mm



2 607 010 079 (5 x)

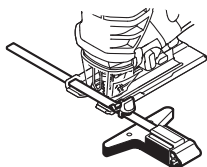

2 607 001 069